

TNC to TNC Quarter Wave Lightning Protector
 1.45 to 1.70 GHz



Features:

- ✦ Low VSWR
- ✦ Low Insertion Loss
- ✦ Extremely High Transient Capability
- ✦ Bi-directional Protection
- ✦ Rugged and Weatherproof

RF Specifications

- ✦ Nominal Impedance 50Ω

Frequency (GHz)	VSWR min / max	Loss (dB) min / max
1.45 - 1.70	1.05 / 1.10	.05 / .10

- ✦ Return Loss (dB typ/min): 32.5/26.5
- ✦ RF Power: 0.15 kW_{avg} / 1.0 kW_{pk}

Transient Specifications

(1.2X50μs Voltage / 8X20μs Current waveform)

- ✦ Maximum Transient: 45 kA_{pk}
- ✦ Multiple Strike: 30 kA_{pk} (10 times)
- ✦ Let Through (V_{peak}/μJ): 10V/15μJ
 Input: 6kV/3kA Output: into 50Ω

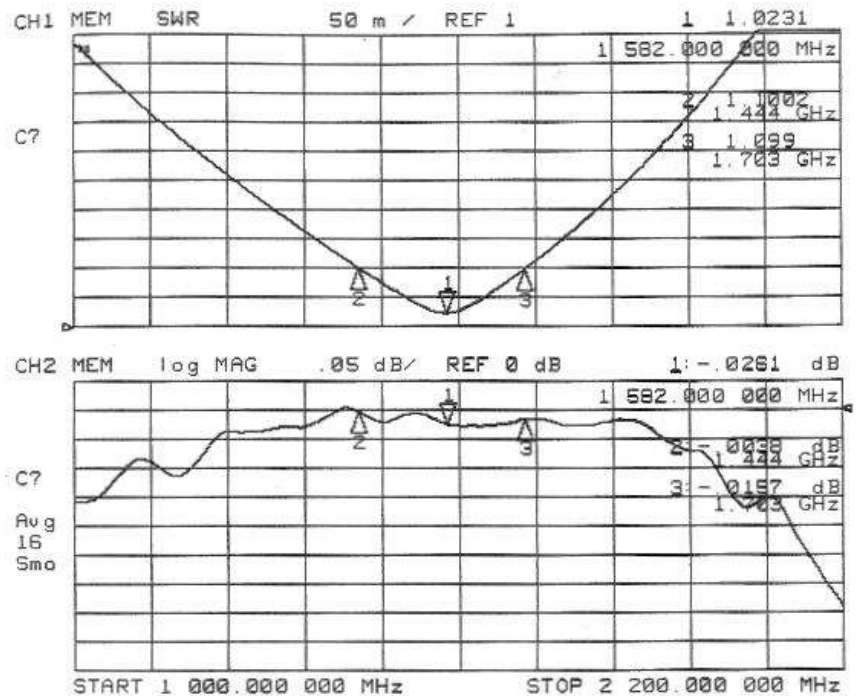

Typical VSWR and Insertion Loss

Mechanical Specifications

- ✦ Mounting/Grounding: ϕ .500 (12.7) bulkhead mount with environmental gasket. Grounding can also be via a bracket or wire lug to the bulkhead connector.
- ✦ Weight: 0.15 pounds typ / 70 g typ

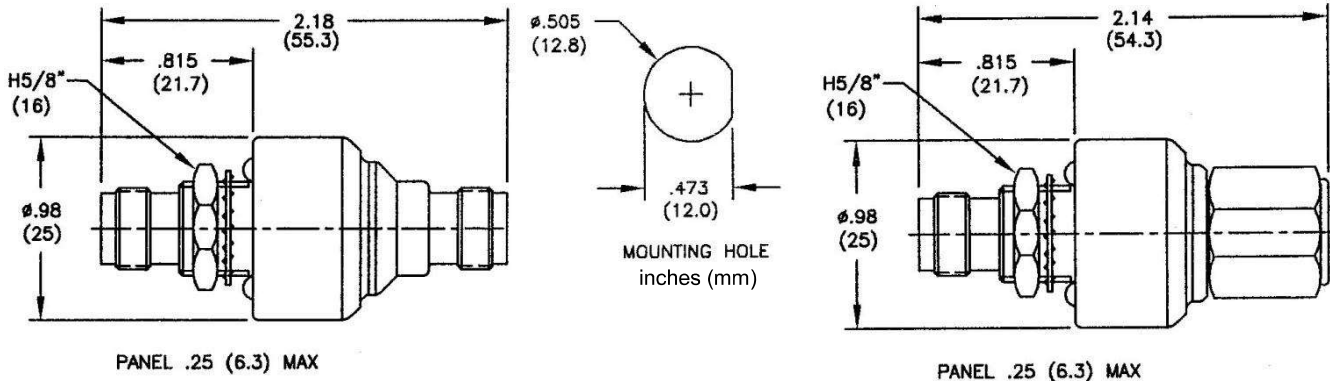

Environmental Specifications

Temperature Range	-40°C to +90°C
Salt Fog	MIL-STD-202 Method 101D / Condition B (35°C/96 hrs)
Immersion	MIL-STD-202 Method 104A / Condition A (65°C to 25°C w/NaCl – 2 cycles)
Moisture Resistance	MIL-STD-202 Method 106E (65°C/98% RH condensing/240 hrs)
Temperature Shock	MIL-STD-202 Method 107D / Condition B-1 (25 cycles -65°C to +125°C)
Life (Elevated Temperature)	MIL-STD-202 Method 108A / Condition A (96 hours at 100°C)
Dust and Waterproof Rating	IEC529 IP68 (dust-tight and water proof 24 hrs / 1 m)
Vibration	MIL-STD-202 Method 204D / Condition D (10Hz-2kHz 0.06"DA/20g)
Mechanical Shock	MIL-STD-202 Method 213 / Condition A (50g/11ms ~24")

Material and Finish

Component	Material	Finish
Outer Parts	Brass	Guardplate™
Center Contact	BeCu	Gold
Insulator	PTFE	-
Gasket	Si Rubber	-

Guardplate™ is an alloy finish with the PIM and conductivity of Silver and the durability and anti-tarnish properties of Nickel.

Part Number

