

# Precision RF & Microwave Components

The Industry Leader for High Frequency Components and Thin Film Fabrication Services



# RF MEASUREMENT CHART

			Relative to Unity Reference			
SWR	Reflection Coefficient	Return Loss (dB)	X dB Below Reference	Ref +X (dB)	Ref -X (dB)	Ref ±X (dB)
17.3910	0.8913	1	1	5.5350	19.2715	24.8065
8.7242	0.7943	2	2	5.0780	13.7365	18.8145
5.8480	0.7079	3	3	4.6495	10.6907	15.3402
4.4194	0.6310	4	4	4.2489	8.6585	12.9073
3.5698	0.5623	5	5	3.8755	7.1773	11.0528
3.0095	0.5012	6	6	3.5287	6.0412	9.5699
2.6146	0.4467	7	7	3.2075	5.1405	8.3480
2.3229	0.3981	8	8	2.9108	4.4096	7.3204
2.0999	0.3548	9	9	2.6376	3.8063	6.4439
1.9250	0.3162	10	10	2.3866	3.3018	5.6884
1.7849	0.2818	11	11	2.1567	2.8756	5.0322
1.6709	0.2512	12	12	1.9465	2.5126	4.4590
1.5769	0.2239	13	13	1.7547	2.2013	3.9561
1.4985	0.1995	14	14	1.5802	1.9331	3.5133
1.4326	0.1778	15	15	1.4216	1.7007	3.1224
1.3767	0.1585	16	16	1.2778	1.4988	2.7766
1.3290	0.1413	17	17	1.1476	1.3227	2.4703
1.2880	0.1259	18	18	1.0299	1.1687	2.1986
1.2528	0.1122	19	19	0.9237	1.0337	1.9574
1.2222	0.1000	20	20	0.8279	0.9151	1.7430
1.1957	0.0891	21	21	0.7416	0.8108	1.5524
1.1726	0.0794	22	22	0.6639	0.7189	1.3828
1.1524	0.0708	23	23	0.5941	0.6378	1.2319
1.1347	0.0631	24	24	0.5314	0.5661	1.0975
1.1192	0.0562	25	25	0.4752	0.5027	0.9779
1.1055	0.0501	26	26	0.4248	0.4466	0.8714
1.0935	0.0447	27	27	0.3798	0.3969	0.7765
1.0829	0.0398	28	28	0.3391	0.3529	0.6919
1.0736	0.0355	29	29	0.3028	0.3138	0.6166
1.0653	0.0316	30	30	0.2704	0.2791	0.5495
1.0580	0.0282	31	31	0.2414	0.2483	0.4897
1.0515	0.0251	32	32	0.2155	0.2210	0.4365
1.0458	0.0224	33	33	0.1923	0.1967	0.3890
1.0407	0.0200	34	34	0.1716	0.1751	0.3467
1.0362	0.0178	35	35	0.1531	0.1558	0.3090
1.0322	0.0158	36	36	0.1366	0.1388	0.2753
1.0287	0.0141	37	37	0.1218	0.1236	0.2454
1.0255	0.0126	38	38	0.1087	0.1100	0.2187
1.0227	0.0112	39	39	0.0969	0.0980	0.1949
1.0202	0.0100	40	40	0.0864	0.0873	0.1737
1.0180	0.0089	41	41	0.0771	0.0778	0.1548
1.0160	0.0079	42	42	0.0687	0.0693	0.1380
1.0143	0.0071	43	43	0.0613	0.0617	0.1230
1.0127	0.0063	44	44	0.0546	0.0550	0.1096
1.0113	0.0056	45	45	0.0487	0.0490	0.0977
1.0101	0.0050	46	46	0.0434	0.0436	0.0871
1.0090	0.0045	47	47	0.0387	0.0389	0.0776
1.0080	0.0040	48	48	0.0345	0.0346	0.0692
1.0071	0.0035	49	49	0.0308	0.0309	0.0616
1.0063	0.0032	50	50	0.0274	0.0275	0.0549
1.0057	0.0028	51	51	0.0244	0.0245	0.0490
1.0050	0.0025	52	52	0.0218	0.0218	0.0436
1.0045	0.0022	53	53	0.0194	0.0195	0.0389
1.0040	0.0020	54	54	0.0173	0.0173	0.0347
1.0036	0.0018	55	55	0.0154	0.0155	0.0309
1.0032	0.0016	56	56	0.0138	0.0138	0.0275
1.0028	0.0014	57	57	0.0123	0.0123	0.0245
1.0025	0.0013	58	58	0.0109	0.0109	0.0219
1.0022	0.0011	59	59	0.0097	0.0098	0.0195
1.0020	0.0010	60	60	0.0087	0.0087	0.0174

- The first three columns are conversion tables for return loss, reflection coefficient, and SWR.
- The last four columns are values for interactions of a small phasor X with a large phasor (unity reference) expressed in dB related to reference.

The RF Measurement Chart can be used to determine the uncertainty due to bridge/autotester VNA directivity. The "X dB Below Reference" column represents the difference between the directivity and the measured reflection (return loss). The "ref + X dB" and "ref - X dB" values are the algebraic sum of the error signal and the measured reflected signal as their phase relationship varies over 360°. Therefore, the peak-to-peak ripple (1 ± X) is the total measurement uncertainty caused by the error signal.

For example, if a 30 dB return loss is measured with a 40 dB directivity auto-

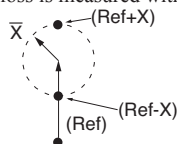

Phasor Interaction

tester, the X dB Below Reference value is 10 dB. Ref + X dB is 2.3866 dB and ref - X dB is 3.3018 dB. The actual return loss is between 27.6134 dB (- 30 + 2.3866) and 33.3018 dB (- 30 - 3.3018). The peak to peak ripple on a swept measurement will be 5.6884 dB. If the error and directivity signals are equal, ref + X dB equals 6 dB (voltage doubled causes 6 dB change) and ref - X dB becomes infinite, since the two signals are equal in amplitude and 180° out of phase (zero voltage).

## ANSI Standard

X mm	±5 mm
X.X mm	±0.5 mm
X.XX mm	±0.15 mm
X.XXX mm	±0.05 mm

Above ANSI Standard tolerance applies to all components unless otherwise noted.

**For further information about these products and more, contact us at 1-800-ANRITSU or visit [www.anritsu.com](http://www.anritsu.com)**

# TABLE OF CONTENTS

## Outline of Precision Measurement Components..... 2

## Microelectronics Fabrication Center ..... 4

## High Return Loss Connectors and Cables

K Connector® ..... 6

V Connector®..... 11

W1 Connector®..... 16

RF Cables K120, V120 ..... 19

Armored Semi-Rigid Test Port Cables ..... 22

## Instrument Grade Adapters

Coaxial Adapters K, V, K to V ..... 23

Panel Coaxial Adapters ..... 24

Calibration Grade Adapters 33 Series..... 25

Instrumentation Grade Adapters 34 Series ..... 29

Precision Adapters ..... 29

Ruggedized Adapters ..... 29

Instrumentation Grade Adapters 34 Series W to V ..... 30

Instrumentation Grade Waveguide Adapters 35WR Series..... 31

## Precision Terminations

Coaxial Terminations 28 Series ..... 35

Coaxial Terminations K210, V210 ..... 36

Fixed Attenuators 41, 43 Series ..... 37

Step Attenuators 4400, 4500, 4600 Series ..... 39

## Measurement Components and Accessories

Airlines 18, 19 Series ..... 41

Open/Shorts 22 Series..... 42

OSL Series Calibration Kits..... 43

TOSL Series Calibration Kits .....44

Microwave Detectors 70, 75 Series ..... 45

Power Dividers 11 Series..... 47

Power Dividers K240, V240 Series ..... 48

Power Splitters K241, V241 Series ..... 49

Power Splitters N241 Series ..... 50

Bias Tee K250, V250 Series ..... 51

Ultra-Wideband Bias Tee K251, V251 Series ..... 52

Ultra-Wideband Bias Tee V255..... 54

Kelvin Connection Bias Tee K252, V252 ..... 56

Precision DC Blocks K261, V261 ..... 57

DC Blocks V265 ..... 59

Universal Test Fixture 3680 Series..... 61

Limiters 1 Series ..... 64

Matching Pads 12 Series..... 65

VNA and VNMS Calibration Kits ..... 66

VNA and VNMS Verification Kits..... 68

Part Number Index ..... 69

RoHS Compliance: Some products are in transition towards RoHS compliance and will have a –R suffix at the time of your order. Please contact Anritsu for further details and the latest compliance status of a particular product.

# OUTLINE OF PRECISION MEASUREMENT COMPONENTS



## Precision Components-Precision Measurements

Anritsu is a leader in the design and production of precision microwave components.

- Precision Coaxial Connector Systems to 145 GHz
- Precision Coaxial and Waveguide to Coax Adapters
- RF Detectors
- Precision Terminations and Air lines
- Precision Fixed Attenuators
- Precision Step Attenuators
- Precision Power Dividers and Splitters
- Precision Bias Tees
- Broadband Microwave Limiters

## Connector Design Leadership

Anritsu is the leader of high frequency microwave connector technology and is driven by an ongoing commitment to exceed customer needs. Anritsu created and trademarked the K Connector® with coverage to 40 GHz, along with a complete family of 40 GHz test equipment. It was an immediate success and today is used on many commercial components, test fixtures, and military systems.

The V Connector® offers coaxial coverage to 65 GHz and uses a 1.85 mm geometry endorsed by the International Electrotechnical Commission (IEC). It mates with commercially available 2.4 mm connectors.

The W1 Connector™ provides mode-free performance to 110 GHz and uses a 1.00 mm coaxial connector front side interface.

The 0.8 mm Connector family is a complete coaxial connector system with single-mode performance to 145 GHz. It contains male and female non-hermetic connectors, male and female broadband terminations and in series adapters. The 0.8 mm Connector is well suited for high frequency applications ranging from components to systems and instrumentation.

## Coaxial and Waveguide to Coax Adapters

A series of precision measurement adapters are available to adapt one connector type to another. Poor adapter VSWR (or poor return loss) can be a major source of measurement error and, therefore adapters, must be carefully selected. Anritsu precision adapters typically have 6-12 dB better return loss than competitive units. Waveguide-to-Coax Adapters are available to 110 GHz.

## Precision Terminations and Air Lines

Anritsu is recognized as the leader in the field of impedance standards. Anritsu air lines and terminations are unsurpassed for accuracy and impedance match. Not only do these products increase measurement accuracy, they also provide the only method of certifying the performance of SWR Autotesters, bridges, directional couplers, and other devices.

## Precision Fixed Attenuators

Anritsu attenuators offer superior performance in a low cost package. The low VSWR (excellent return loss) minimizes signal reflections and simultaneously reduces ripple effects in the output frequency response. This assures flat, consistent attenuation characteristics regardless of other devices reflection characteristics. One of the simplest ways to improve impedance match is to insert a precision attenuator between the device under test and the source or RF detector. The 41K and 41V Series attenuators are specifically designed for such applications where accuracy is a basic requirement.

In addition to being available as individual units of 3, 6, 10, or 20 dB, the 41K and 41V Series Fixed Attenuators are also available in sets with certified calibration data. Available frequency ranges cover DC to 26.5 GHz, 40 GHz, or 60 GHz.

Many other attenuator applications have as their principal objective the reduction of power. Since the attenuator might not be inserted at a measurement point, the measurement precision discussed earlier is not required. In such a power-reducing system application, attenuators are often required in large quantities, making price an important consideration. The 43K Series includes models covering DC to 26.5 GHz, and DC to 40 GHz. All are available with 3, 6, 10, or 20 dB attenuation values. All have the Anritsu K Connectors and are compatible with SMA connectors.

Whatever your fixed attenuator needs might be, Anritsu provides the solution.



## Precision Step Attenuators

Anritsu offers low loss, high precision step attenuators. These programmable step attenuators are available with 10 dB steps from 0 to 70 dB or 0 to 110 dB ranges. DC to 40 GHz frequency range ensures the broadest attenuation and frequency coverage available. Contact Anritsu for needs above 40 GHz or for custom step sizes.

## Precision Power Dividers and Splitters

Anritsu produces precision V Connector® dividers and splitters to 65 GHz and precision K Connector® dividers and splitters to 40 GHz.

All Anritsu power dividers are 3-resistor symmetrical designs with excellent amplitude and phase tracking. Anritsu power splitters are 2-resistor designs, used to accurately split signals for ratio measurements.

## Precision Bias Tees

Anritsu Bias Tees are used to combine DC and RF for active device measurements. Low RF throughline loss and low SWR ensure negligible effect on measurements from 50 kHz to 65 GHz.

## Broadband Microwave Limiters

Anritsu broadband microwave limiters provide the widest frequency range available in a limiter. Designed to protect sensitive microwave equipment, these limiters incorporate unique single-side limiting to provide soft limiting characteristics over 10 MHz to 26.5 GHz.

## RF Detectors

Just as directivity is the principal error contributor in reflection measurements, the impedance match of the signal source and RF detector is a significant error contributor in transmission measurements.

Anritsu offers a complete line of coaxial RF detectors covering from 10 MHz to 50 GHz with the lowest SWR available. The excellent impedance match of the detectors minimize measurement errors.

## Calibration and Verification Kits

Anritsu offers calibration kits which contain all of the precision components and tools required to calibrate an Anritsu VNA in a connector style of your choice.

## Specials

Anritsu also manufactures assemblies and components to meet specific customer requirements in both coaxial and waveguide structures. These include such components as Connectors, Bias Tee, Step Attenuator, Detector, Power Sensors, Waveguide, Coaxial Adapters, and RF Cables etc.

When requesting quotations on special assemblies, as a minimum please provide this information: frequency range, electrical characteristics, mechanical details and outline dimensions if any.

## Your Solution for Fabrication and Assembly Needs

Anritsu Microelectronics Fabrication Center, conveniently located south of Silicon Valley in Morgan Hill, CA, includes a 8000 sqft class 100/10,000 clean room, a 25,000 sq. ft. RF/Microwave assembly manufacturing facility, and a state of the art machining center. We are proud to be your partner for thin film device fabrication, microelectronic assembly, packaging, and machining.

### QUALITY

Custom Thin Film Devices  
GaAs/InP Optoelectronics Wafer Foundry  
MEMs  
Rapid Prototyping

### RELIABILITY

High Volume High Quality Production  
Process Engineering Support  
Microelectronic Assembly  
Testing and Machining

### FLEXIBILITY



#### Thin Film Fab

##### Photolithography

5x stepper, contact lithography, double sided aligning available

##### Etching

Plasma, RIE, wet etching of metal, silicon, nitride, and oxide

##### Dielectric Deposition

Plasma-Enhanced CVD

##### Metal Deposition

Sputtering, E-Beam Evaporation

##### Other Process Capabilities

Selective gold and AuSn electroplating  
Polyimide, BCB, and Si<sub>3</sub>N<sub>4</sub> Capacitors  
Integrated Resistors  
Filled and Plated Through vias  
Wrap-arounds  
Precision Laser Resistor Trimming  
Full Support Custom Product Development

##### Material

Alumina, Aluminum Nitride, Fused Silica, Sapphire, Glass, Silicon, GaAs and InP wafers, CVD Diamond, etc.



Anritsu Company is a global leader in RF/Microwave test and measurement equipment for laboratories and field applications.

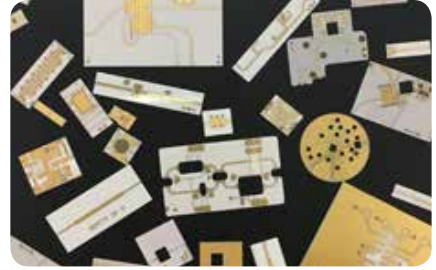
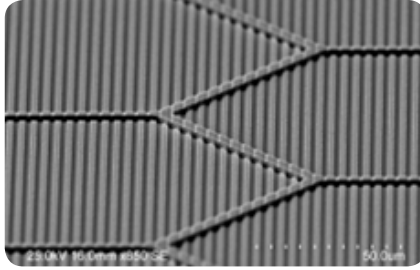
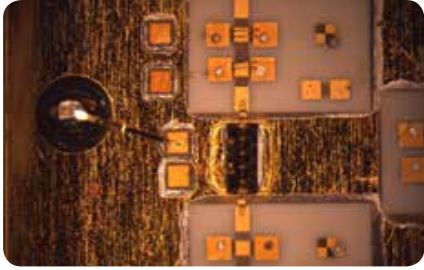

## • CONVENIENCE

## • QUICK DELIVERY

### Markets Served

- Telecommunications
- Civil Aviation and Aerospace
- Automotive
- Defense
- Biotechnology and Medical
- Solar



### Microelectronic Manufacturing

#### Assembly Equipment and capabilities

Auto Wedge Bonder, SEM, Acoustic Microscope, Eutectic Die Attach, Epoxy Die Attach, Gap Welding, Wedge Bonding, Tack Bonding, Ball Bonding, Sheet Epoxy Attach, Non-conductive Epoxy Attach, Hermetically Sealed Connector Assembly, Soldering (*AuSn, Indium, SnPb, Gold Germanium, RoHs Compliant solders available*)

#### Testing

DC-145GHz range, S Parameters, Noise figure, Noise Floor, Dynamic range, IIP3/OIP3, Harmonic levels, Phase noise

#### Reliability Testing

IC thermal imaging, Material Analysis, HALT and HASS testing, Environmental testing, Burn-in, Power Cycling, EMI/EMC testing, Drop testing, Die Attach Void testing, Temperature Cycle with or without testing, shear and pull testing

#### Machining

CNC and manual Mills and Lathes

# K CONNECTOR®

DC to 40 GHz

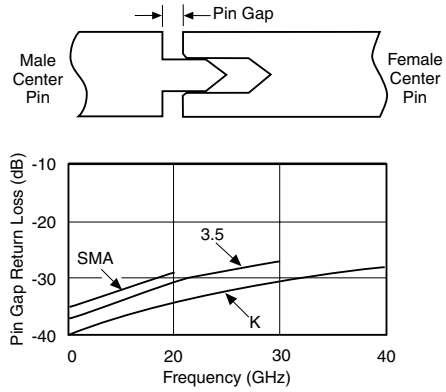
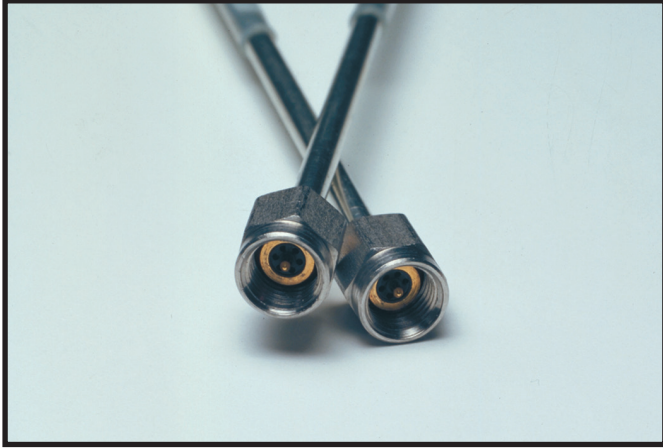

Effect of Pin Gap

The K Connector® is a precision coaxial connector system that operates up to 40 GHz. It is compatible with SMA, WSMA, and 3.5 mm connectors. It is well suited for applications in components, systems, or instrumentation.

Visit [www.anritsu.com](http://www.anritsu.com) for the latest information including installation instructions, outline drawings, and RoHS compliance status.

## K Connector® features

- Excellent performance up to 40 GHz
- Performance exceeding SMA below 18 GHz
- Superior reliability
- Compatibility with SMA, WSMA, and 3.5 mm
- Complete testability on existing network analyzers
- Components with -R suffix are RoHS compliant

## Exceptional reliability and repeatability

Microwave connector reliability is affected by insertion force, outer conductor strength, stress relief while mating, and mating alignment. The K Connector exhibits exceptional performance in all of these areas.

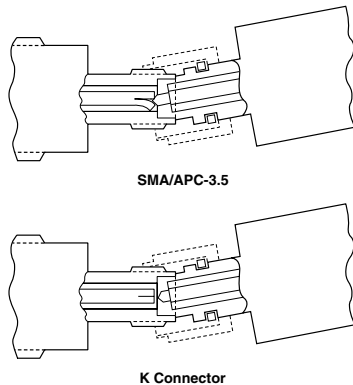

Shortened Male Pin Eliminates Damage to Female K Connector

For proper seating, a standard SMA or 3.5 mm connector can require in excess of 27N\* of insertion force. In contrast, the K Connector requires only 2.3N\*. The reduced wear on the female center conductor improves reliability. In addition, the K Connectors outer conductor is four times thicker than that of SMA. Taken together, the lower insertion force and the thicker wall offer more reliable connections than available from an SMA connector. Life tests show that the K Connector makes greater than 10,000 connections with negligible change in electrical characteristics.

All K Connectors, including the cable connectors, incorporate a feature that eliminates a major cause of connector failure; misalignment of the male pin with respect to the female contacts. To solve the problems the K Connector male pin is deliberately made shorter than the SMA or 3.5 mm pin. With this arrangement, the outer housing is properly aligned prior to the mating of the center conductors. Thus a proper, non-destructive alignment before mating is ensured.

The effect of pin gap on a connection is often overlooked, but is the dominant source of error in many connection systems. Pin gap is the short length of smaller diameter caused when a connector pair is mated. Pin gap causes a discontinuity at the connector interface. The K Connector has considerably less susceptibility to pin gap than either SMA or 3.5 mm connectors.

Many connector manufacturers specify connector performance assuming no pin gap, an unrealistic assumption. K Connectors are specified assuming pin gap to be at its maximum tolerance, to provide you the assurance of real-world specifications.

## Compatibility

The K Connector interfaces electrically and mechanically with 3.5 mm connectors, including SMA and 3.5 mm without degradation in performance.

## Launcher design

At the heart of the K Connector product line are the launchers. As their name implies, the launchers “launch” (make the transition) from a microwave circuit (microstrip, suspended substrate, stripline, or coplanar waveguide) to a coaxial connector and an outside transmission line. The key to making the transition without compromising electrical and mechanical objectives is the glass bead in the launcher assembly.

\*Force is measured in Newtons (N).



# K CONNECTOR®

DC to 40 GHz

## Low-reflection bead

The K Connector®'s standard glass bead has a 0.30 mm center conductor and readily connects to fragile devices. The bead is appropriate for most applications employing Duroid® and ceramic (Alumina) microstrip, such as the 0.25 mm wide transmission line on a 0.25 mm thick Alumina substrate. Applications using suspended substrate geometry are equally well satisfied. The bead is constructed of Corning 7070 glass and has a gold-plated center conductor and a gold-plated Kovar® collar.

The outstanding design of the bead is largely accountable for the excellent performance of the K Connector launchers. Because the small 0.30 mm pin introduces minimal discontinuity, return loss is typically better than 20 dB at 40 GHz and better than 25 dB below 18 GHz. In addition, the design provides for soldering the bead to achieve a hermetic seal. 310°C max. soldering temperature is recommended.

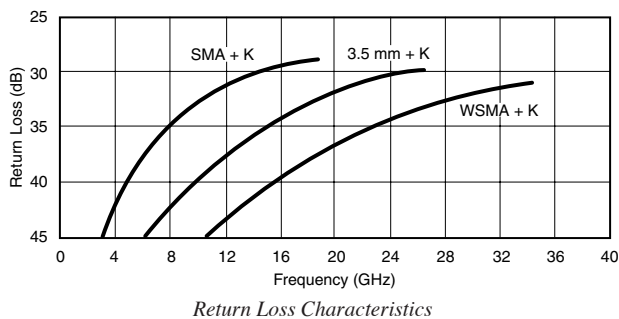

Both the sparkplug (screw-in) and the flange-mount K Connector launchers offer an additional advantage over existing designs. These launchers do not use an epoxy pin to secure the center conductor, as used in some SMA designs. Without an epoxy pin, the outer conductor remains solid, and thereby eliminates the leakage path common to pin-captivated designs. Furthermore, K launchers have a wall thickness that is four times that of typical launchers (0.8 vs. 0.2 mm). The heavier wall results in superior resistance to over-torquing. Finally, the K Connector launcher can be removed for repair without removal of the glass bead. This ensures that during removal the critical microcircuit-to-glass bead interface is not disturbed, hermeticity is preserved, and the micro-circuit will not be subjected to the additional stress caused by heating to soldering temperature. Hardware locking compound such as "Removable Loctite®" should be used to further secure the screw-in launcher in its housing.

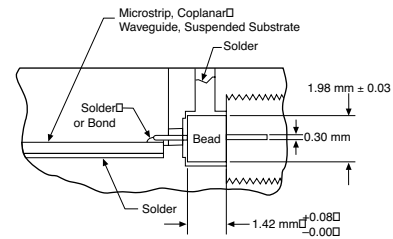

Transition from Microcircuit to External Transmission Line

## Complete family

Virtually every interface need can be satisfied by one or more of the K Connector items offered. There are six different models of K Connector launchers. Two sparkplug (screw-in) launchers are available, the K102F-R female version and the K102M-R male version. Both screw into the housing that encloses the microwave circuit, and, like all Anritsu launchers, they can be easily removed for replacement or repair without unsoldering the glass bead and its interface to the microwave circuit.

When the housing that encloses the microwave circuit is not thick enough to support a threaded, screw-in launcher, flush-mounted (flange) launchers are required. Models with two mounting holes are available in both male and female versions, K103M-R and K103F-R. Two other models, the K104F-R and K104M-R, have four mounting holes. Mounting hole spacing is identical to that of similar SMA flange launchers. The glass bead interface, of course, is the same design used for the sparkplug launcher.

## Cable connectors

Both male and female cable connectors are available. The cable connectors, K101M-R and K101F-R, use gold-plated, beryllium-copper center conductors for optimum performance and wear characteristics. Typical return loss at 40 GHz for finished cables exceeds 16 dB (1.35 SWR).

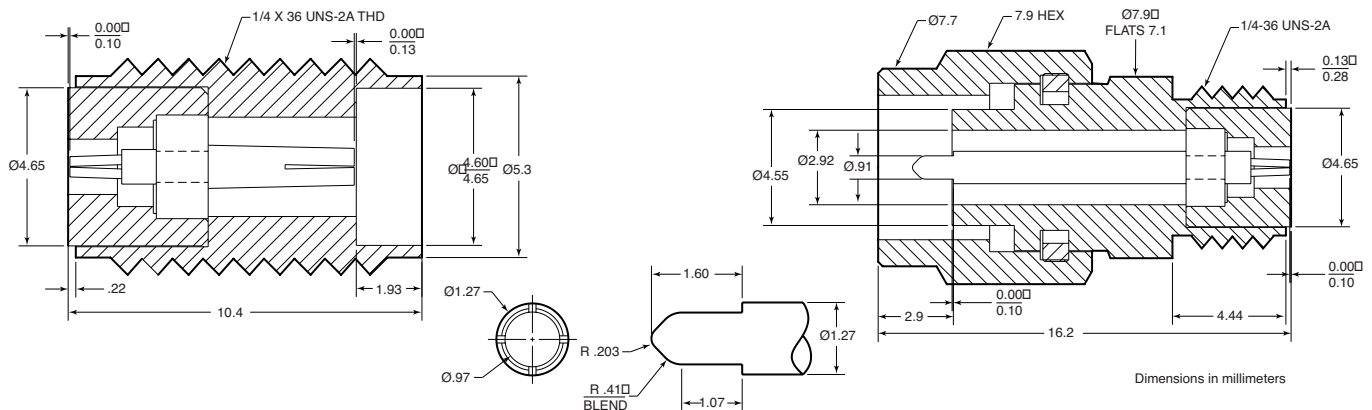

K Connector® interface dimensions in metric measurements

# K CONNECTOR®

DC to 40 GHz



## Evaluation kit

**01-101A**

### Evaluation Kit

Kit contains one K120 25 cm Male/Male Cable Assembly, two K102F-R Female Sparkplug Launcher Connector Assemblies, two K104F-R Female Flange Launcher Connector Assemblies, five K100 Glass Beads, one 01-102A Test Fixture, one 01-104 Drill and Tap Set, five K110-1-R Microstrip Sliding Contacts, and all other parts and fixtures required to assemble launchers with or without sliding contacts.

## Tools and fixtures



**01-103**

Soldering Fixture for sparkplug launcher glass beads, package of 10



**01-104**

### Drill and Tap Set

for precision machining of concentric holes for mounting K Connector® in microwave housing. (Drill Part No. B14094) (Tap Part No. 783-255)



**01-105A**

Male and Female Sparkplug Torquing Kit

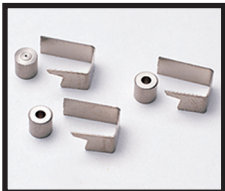

**01-106**

K Soldering Fixture for flange launcher glass bead, package of 5.



**01-107M or 01-107F**

Cable Sleeve Soldering Fixture for K101M-R Male and K101F-R Female Cable Connectors, package of 10.



**01-108**

### Drill and Tap Set

For precision machining of concentric holes for mounting K Connector® in microwave housing in applications where stress relief contacts are used. (Drill Part No. B16526) (Tap Part No. 783-255)



**01-118**

K Connector® Cable Assembling Fixture Kit for K118 semi-rigid coaxial cable.



**01-201**

Torque wrench: 0.9 N-M (8 in-lb) for standard SMA and 3.5 mm connectors, and for the Anritsu K Connector® and V Connector®.



**01-202**

Universal Connection Wrench



**01-203**

Torque End Wrench

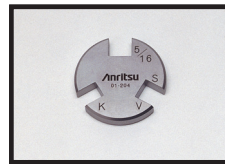

**01-204**

Handy stainless steel connector wrench for standard SMA, 3.5 mm, and 2.4 mm connectors, and for the Anritsu K Connector® and V Connector®.

## Semi-rigid coaxial cable

Type	Semi-rigid coaxial, tin or tin-bismuth plated copper outer conductor, silver-plated copper center conductor.
Impedance	50 ± 2 Ω
Dielectric type	Microporous PTFE
Dielectric constant	1.687
Relative velocity	0.78
Outside diameter	2.95mm
Center conductor diameter	0.81 mm
Minimum bend radius	1.3 cm
Attenuation	1.6 dB/m at 10 GHz 2.3 dB/m at 20 GHz 3.3 dB/m at 30 GHz 4.7 dB/m at 40 GHz



**K118**

### Semi-rigid Coaxial Cable

1.5m length of 2.95 mm semi-rigid cable for K101 series connector

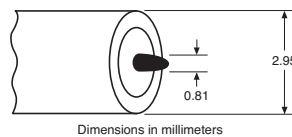

# K CONNECTOR®

DC to 40 GHz

## Launchers and cable connectors

<b>Coupling nut tightening torque</b>	1.36 N-m max
<b>Material</b>	Passivated stainless steel with heat-treated beryllium copper center conductors
<b>Pin depth</b>	0.000 to -0.13 mm for male and female connectors
<b>Temperature range</b>	-55°C to +125°C (200°C available; contact factory)



**K101M-R<sup>④⑥</sup>**  
K Male In-Line Cable Connector, DC-40 GHz for 2.95 mm cable  
**K101M-085-R<sup>④</sup>**  
for 2.18 mm cable



**K101F-R<sup>⑤⑥</sup>**  
K Female In-Line Cable Connector, DC-40 GHz for 2.95 mm cable



**K102M-R<sup>①②③</sup>**  
K Male Sparkplug Launcher Connector, DC-40 GHz

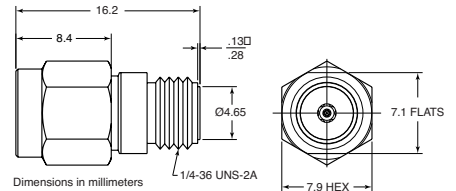
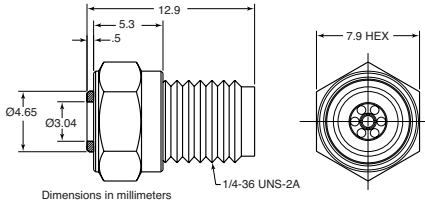
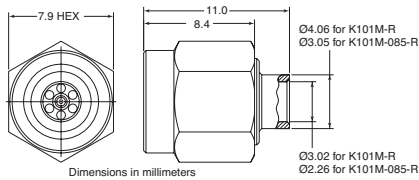

**K102F-R<sup>①②③</sup>**  
K Female Sparkplug Launcher Connector, DC-40 GHz



**K103M-R<sup>①⑦</sup>**  
K Male Flange Launcher, two-hole, DC-40 GHz



**K103F-R<sup>①⑦</sup>**  
K Female Flange Launcher, two-hole, DC-40 GHz

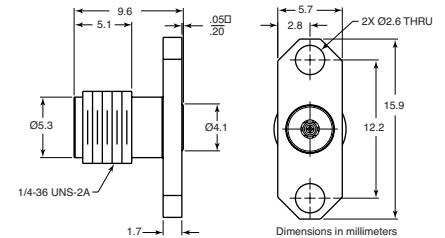
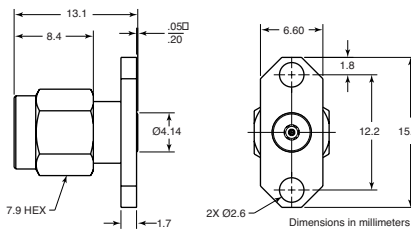
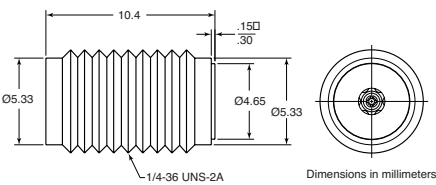

**K104M-R<sup>①⑦</sup>**  
K Male Flange Launcher, four-hole, DC-40 GHz



**K104F-R<sup>①⑦</sup>**  
K Female Flange Launcher, four-hole, DC-40 GHz

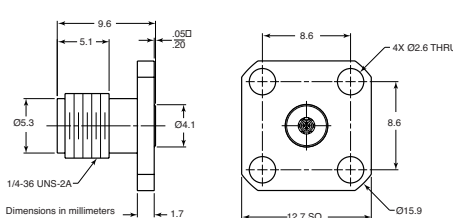
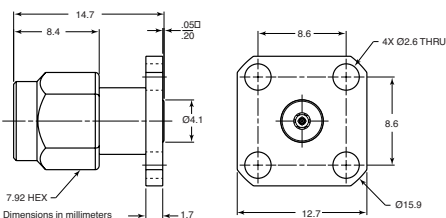

- ① Use with 01-104 or 01-108 Drill and Tap Sets
- ② Use with 01-103 Soldering Fixture
- ③ Use with 01-105A Male and Female Sparkplug Torquing Kit
- ④ Use with 01-107M Cable Sleeve Fixture
- ⑤ Use with 01-107F Cable Sleeve Fixture
- ⑥ Use with 01-118 Cable Assembly Fixture Kit
- ⑦ Use with 01-106 Soldering Fixture

# K CONNECTOR®

DC to 40 GHz

<b>Frequency range</b>	DC to 40 GHz
<b>Material</b>	0.025 mm heat-treated BeCu
<b>Plating</b>	Bondable gold over nickel

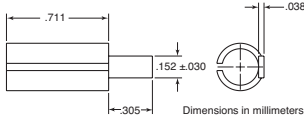

**K110-1-R**® Microstrip and Coplaner Waveguide

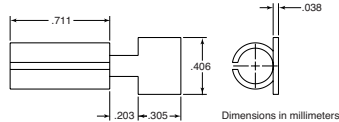

**K110-3-R**® Microstrip

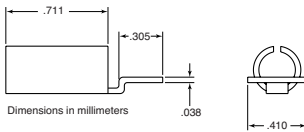

**K110-2-R**® Stripline

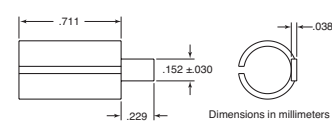

**S110-1** Microstrip and Coplaner Waveguide for 0.38 mm glass feedthru center conductor

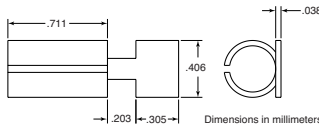

**S110-3** Microstrip and Coplaner Waveguide for 0.38 mm glass feedthru center conductor

☐ Use with 01-108 Drill and Tap Set

## Ordering information

Please specify model/order number, name, and quantity when ordering.

Model/Order No.	Name
01-101A	K Connector® (evaluation kit)
01-103	Soldering fixture for sparkplug launcher glass bead
01-104	Drill and tap set
01-105A	Male and female sparkplug torquing kit
01-106	Soldering fixture for flange launcher glass bead
01-107F	Cable sleeve soldering fixture, female connector
01-107M	Cable sleeve soldering fixture, male connector
01-108	Drill and tap set
01-118	Cable assembling fixture for K118 semi-rigid coax cable
01-201	Torque wrench, for SMA, 3.5mm, and K Connector and V Connector
01-202	Universal test port connector wrench
01-203	Torque wrench: 0.9 N-M (8in-lb) for standard N connectors
01-204	Anritsu stainless steel connector wrench
01-524	0.8mm-6mm torque wrench
01-525	6X7mm end wrench
K110-1-R*	Microstrip stress relief contact
K110-2-R*	Stripline stress relief contact
K110-3-R*	Microstrip stress relief contact
K101M-R	K(m) in-line cable connector, DC to 40 GHz for K118 cable
K101M-085-R	K(m) in-line cable connector, DC to 40 GHz for V085 cable
K101F-R	K(f) in-line cable connector, DC to 40 GHz
K102M-R	K(m) sparkplug launcher connector, DC to 40 GHz
K102F-R	K(f) sparkplug launcher connector, DC to 40 GHz
K103M-R	K(m) flange launcher connector, DC to 40 GHz, 2 mounting holes
K103F-R	K(f) flange launcher connector, DC to 40 GHz, 2 mounting holes
K104M-R	K(m) flange launcher connector, DC to 40 GHz, 4 mounting holes
K104F-R	K(f) flange launcher connector, DC to 40 GHz, 4 mounting holes
K118	Coaxial cable, 1.5m of 2.95 mm semi-rigid cable for K101 series connector
S110-1*	Microstrip and coplaner waveguide stress relief contact for 0.38 mm glass feedthru center conductor
S110-3*	Microstrip and coplaner waveguide stress relief contact for 0.38 mm glass feedthru center conductor

\*Sold in multiples of 10 only.

# V CONNECTOR®

DC to 65 GHz



The V Connector® is a reliable 1.85 mm device that operates up to 65 GHz. It is compatible with 2.4 mm connectors and is assembled using procedures that are similar to those used on K Connectors. It is well suited to applications in components, systems, or instrumentation.

Visit [www.anritsu.com](http://www.anritsu.com) for the latest information including installation instructions, outline drawings, and RoHS compliance status.

## V Connector® features

- Excellent performance up to 65 GHz
- Low VSWR
- Superior reliability
- Low Loss
- Components with -R suffix are RoHS compliant

## Exceptional reliability and repeatability

Microwave connector reliability is affected by insertion force, outer conductor strength, stress relief while mating, and mating alignment. The V Connector exhibits exceptional performance in all of these areas.

For proper seating, the V Connector requires only 1/2 the insertion force of a 2.4 mm connector. The reduced wear on the center conductor equates to greater reliability. All V Connectors, including the cable connectors, incorporate another feature that eliminates a major cause of connector failure: misalignment of the male pin with respect to the female. To solve the problem, the V Connector male pin is deliberately made sufficiently short to prevent damage to the female connector by misalignment. With this arrangement, the outer housing must be properly aligned prior to the mating of the center conductors. Thus a proper, non-destructive alignment before mating is ensured.

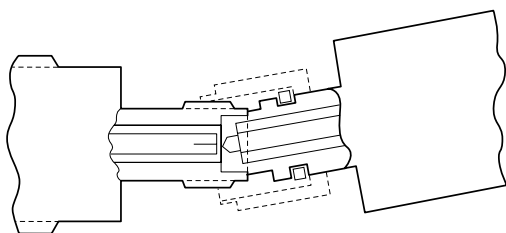

V Connector

Shortened Male Pin Eliminates Damage to Female V Connector

The effect of pin gap on a connection is often overlooked, but is the dominant source of error in many connection systems. Pin gap is the short length of smaller diameter created when a connector pair is mated. Pin gap causes a discontinuity at the connector interface. The V Connector has considerably less susceptibility to pin gap than 2.4 mm connectors.

Many connector manufacturers specify connector performance assuming no pin gap, an unrealistic assumption. V Connectors are specified assuming pin gap to be at its maximum tolerance, to provide you the assurance of real-world specifications.

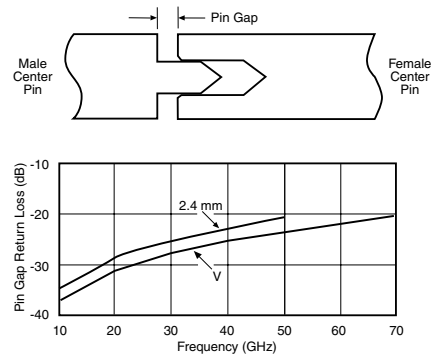

Effect of Pin Gap

## Launcher design

At the heart of the V Connector product line are the launchers. As their name implies, the launchers make the transition from a microwave circuit (microstrip, suspended substrate, stripline, or coplanar waveguide) to a coaxial connector and an outside transmission line. The key to making the transition without compromising electrical and mechanical objectives is the glass bead in the launcher assembly.

## Low-reflection glass bead

The V Connector's standard glass bead has a unique 0.24 mm center conductor and readily connects to fragile devices. The bead is appropriate for most applications employing Duroid and ceramic (Alumina) microstrip, such as the 0.25 mm wide center conductor on a 0.25 mm thick Alumina substrate. Applications using suspended substrate geometry are equally well satisfied. The bead is constructed of Corning 7070 glass and has a gold-plated center conductor and a gold-plated Kovar® collar.

The outstanding design of the bead is largely accountable for the excellent performance of the V Connector launchers. In addition, the design provides for soldering the bead to achieve a hermetic seal. A max soldering temperature of 310°C is recommended. The V Connector® launchers can be removed for repair without removal of the glass bead. This ensures that during removal the critical microcircuit-to-glass bead interface is not disturbed, that hermeticity is preserved, and that the microcircuit will not be subjected to the additional stress caused by heating to soldering temperature. Hardware locking compound such as Removable Loctite® should be used to further secure the launcher in its housing.

# V CONNECTOR®

DC to 65 GHz

## Complete family

There are four different models of V Connector launchers. Two types of sparkplug (screw-in) launchers are available: the V102F-R female version and the V102M-R male version. Both screw into the housing that encloses the microwave circuit. And, like all Anritsu launchers, they can be easily removed for replacement or repair without unsoldering the glass bead and its interface to the microwave circuit.

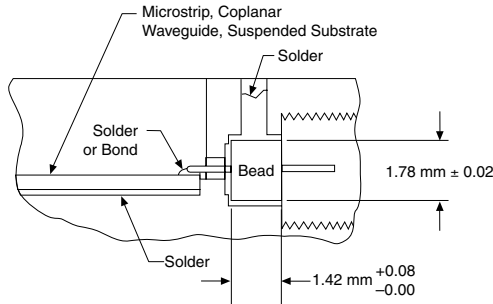

Transition from Microcircuit to Outside Transmission Line

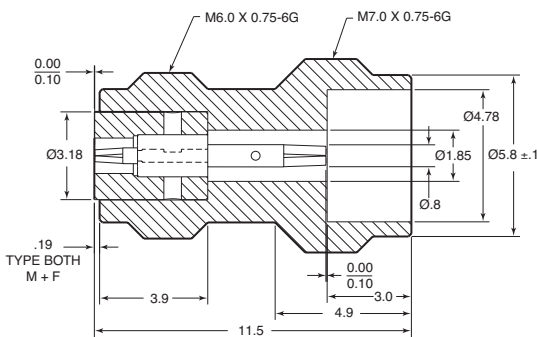

V Connector interface dimensions

When the housing that encloses the microwave circuit is not thick enough to support a threaded, screw-in launcher, flush-mounted (flange) launchers are required. Models with two mounting holes are available in both male and female versions, V103M-R and V103F-R. The mounting hole spacing is identical to that of similar SMA flange launchers. The glass bead interface, of course, is the same design used for the sparkplug launcher.

## Cable connectors

To complement the high performance V085 cable, both male and female cable connectors are available. Typical return loss at 65 GHz for finished cables exceeds 16 dB (1.35 SWR).

The V Connector® coaxial cable connectors use a 2.18 mm cable with a microporous PTFE dielectric and a copper center conductor. The cable assemblies use the center conductor of the coax as the male pin. This is similar to the UT-141 SMA-type assembly and 2.4 mm cable assemblies. The microporous PTFE dielectric has maximum phase stability and minimum insertion loss. This type of cable assembly allows for easy assembly and maximum RF performance; however, since the male pin is copper, the cable assemblies are not suitable for repeated connections. In applications where the cable will be subject to more than 100 connections, we recommend that a connector saver be used.

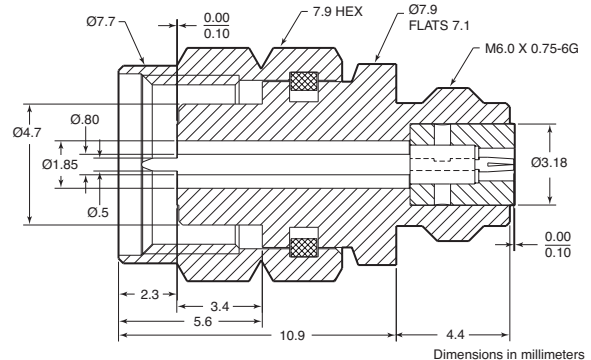

## Evaluation kit

### 01-301

V Connector Evaluation Kit contains one V120MM - 25CM Male/Male Cable Assembly, two V102F Female Sparkplug Launcher Connector Assemblies, two V103F Female Flange Launcher Connector Assemblies, two V101M-R Male In-line Cable Connector Assemblies, five V100 Glass Beads, one 01-304 Drill and Tap Set, one 01-302 Test Fixture, two 01-303 Soldering Fixtures.



## Tools and fixtures

### 01-303

Soldering Fixture for sparkplug launcher glass beads, package of 10.



### 01-304

Drill and Tap Set for precision machining of concentric holes for mounting V Connector in microwave housing. (Drill Part No. 783-568) (Tap Part No. 783-569)



# V CONNECTOR®

DC to 65 GHz

## 01-105A

K and V Connector® Male and Female Sparkplug Torquing Kit.



## 01-306

Soldering Fixture for flange launcher glass bead, package of 5.

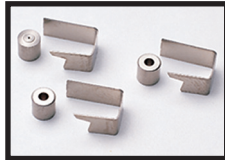

## 01-307M or 01-307F

Cable Sleeve Soldering Fixture for V101M-R Male and V101F-R Female Cable Connectors, package of 10.



## 01-308

Drill and Tap set for precision machining of concentric holes for mounting V Connector in microwave housing in applications where stress-relief contacts are used. (Drill Part No. 55300) (Tap Part No. 783-569)



## 01-309

V Connector Cable Assembling Fixture for V085 semi-rigid cable.



## 01-201

Torque wrench: 0.9 N-M (8 in-lb) for standard SMA and 3.5 mm connectors, and for the Anritsu K Connector® and V Connector®.



## 01-204

Handy stainless steel connector wrench for standard SMA, 3.5 mm, and 2.4 mm connectors, and for the Anritsu K Connector® and V Connector®.

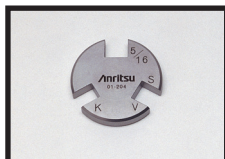

## Semi-rigid coaxial cable

Type	Semi-rigid coaxial, tin/bismuth plated copper outer conductor, silver-plated copper center conductor.
Impedance	50 ± 2 Ω
Dielectric type	Microporous PTFE
Dielectric constant	1.687
Relative velocity	0.77
Outside diameter	2.16 mm
Center conductor diameter	0.51 mm
Minimum bend radius	1.0 cm
Attenuation	2.3 dB/m at 10 GHz 3.6 dB/m at 20 GHz 4.3 dB/m at 30 GHz 5.2 dB/m at 40 GHz 7.2 dB/m at 60 GHz

## V085

Semirigid Coaxial Cable  
1.5 m length of 2.18 mm semirigid cable for V101 series connector

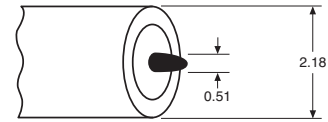

Dimensions in millimeters

## Stress relief contacts

Stress Relief Contacts provide an elegant yet simple solution to relieving stress at the interface of the microcircuit and its connecting coaxial conductor. These contacts simply slide onto the standard glass bead pins and can be soldered, bonded or parallel-gap welded to a circuit trace.

Frequency range	DC to 67 GHz
Material	0.025 mm heat-treated BeCu
Plating	Bondable gold

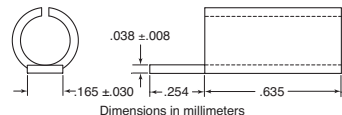

Dimensions in millimeters

## V110-I-R®

Microstrip and Coplanar Waveguide  
when using the V110-I, use 01-308 Drill and Tap set to make the required concentric holes.

## Launchers and cable connectors

Return loss (launchers only)	15 dB up to 65 GHz
Coupling nut tightening torque	1.36 N-m max
Material	Passivated stainless steel with heat-treated beryllium copper center conductors
Pin depth	0.000 to -0.130 mm for male and female connectors
Temperature range	-55°C to +125°C

☐ Use with 01-308 Drill and Tap Set

# V CONNECTOR®

DC to 65 GHz



**V101M-R<sup>②④</sup>**  
V Male In-Line Cable Connector, DC-65 GHz for V085 cable

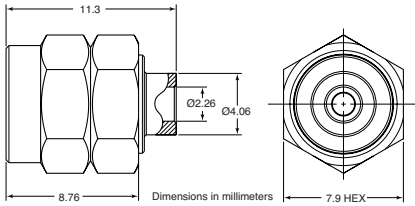

**V101F-R<sup>③④</sup>**  
V Female In-Line Cable Connector, DC-65 GHz for V085 cable

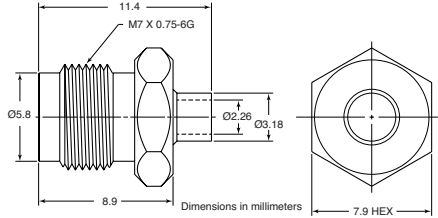

**V102M-R<sup>①⑤⑥</sup>**  
V Male Sparkplug Launcher Connector, DC-65 GHz

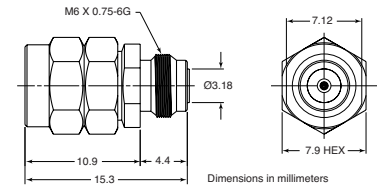

**V102F-R<sup>①⑤⑥</sup>**  
V Female Sparkplug Launcher Connector, DC-65 GHz

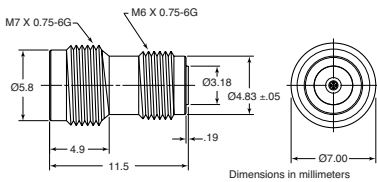

**V103M-R<sup>⑤⑦</sup>**  
V Male Flange Launcher, two-hole, DC-65 GHz

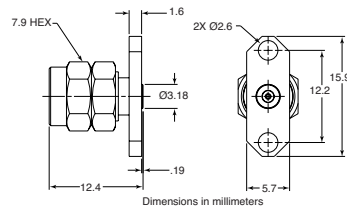

**V103F-R<sup>⑤⑦</sup>**  
V Female Flange Launcher, two-hole, DC-65 GHz

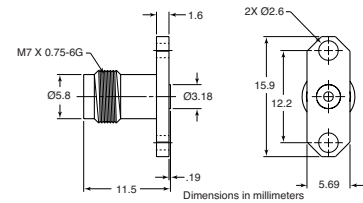

**V103M-012**  
V Male Flange Launcher, two-hole for 0.30 mm glass bead pin, DC-65 GHz

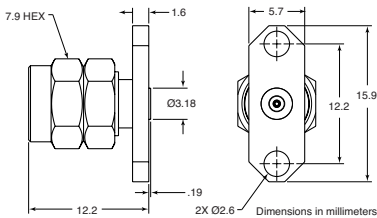

**V103F-012**  
V Female Flange Launcher, two-hole for 0.30 mm glass bead pin, DC-65 GHz

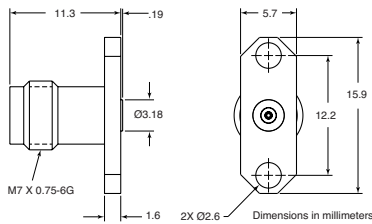

- ① Use with 01-105A Male and Female Sparkplug Torquing Kit
- ② Use with 01-307M Cable Sleeve Fixture
- ③ Use with 01-307F Cable Sleeve Fixture
- ④ Use with 01-309 Cable Assembling Fixture
- ⑤ Use with 01-304 or 01-308 Drill and Tap Sets
- ⑥ Use with 01-303 Soldering Fixture
- ⑦ Use with 01-306 Soldering Fixture



# V CONNECTOR®

DC to 65 GHz

## Environmental information

Tests are performed per MIL-STD-202F.

<b>Operating Temperature Range</b>	-55°C to +125°
<b>Temperature Shock</b>	-55°C to +150°
<b>Humidity</b>	95% at 40°C, 96 hours, Test 103B, Condition B
<b>Shock</b>	100 G peak sawtooth, method 213, Test condition 1
<b>Vibration</b>	Sinewave: 10 Hz to 2000 Hz, 0.06" DA, method 204, test condition D Random: 50 Hz to 2000 Hz, 11.6 Grms, Power Spectral Density 0.1 Grms 2 Hz, Method 214, Test Condition 1, Letter D
<b>Salt Spray</b>	5% concentration for 48 hours, Method 101D, Condition B
<b>Voltage withstanding</b>	500 Vac RMS, 60 seconds, method 301

## Ordering information

Please specify model/order number, name, and quantity when ordering.

Model/Order No.	Name
01-105A	Male and female sparkplug torquing kit
01-201	Torque wrench, for SMA, 3.5mm, and K Connector and V Connector
01-204	Anritsu stainless steel connector wrench
01-301	V Connector® (evaluation kit)
01-303	Soldering fixture for sparkplug launcher glass bead
01-304	Drill and tap set
01-306	Soldering fixture for flange launcher glass bead
01-307M	Cable sleeve soldering fixture, male connector
01-307F	Cable sleeve soldering fixture, female connector
01-308	Drill and tap set
01-309	Cable assembling fixture
V085	Coaxial cable, 152 cm (5 feet) length of 2.18 mm semi-rigid cable
V101M-R	V(m) in-line cable connector, DC to 65 GHz
V101F-R	V(f) in-line cable connector, DC to 65 GHz
V102M-R	V(m) sparkplug launcher connector, DC to 65 GHz
V102F-R	V(f) sparkplug launcher connector, DC to 65 GHz
V103M-R	V(m) flange launcher connector, DC to 65 GHz, 2 mounting holes
V103M-012	V(m) flange launcher, 2 mounting holes for 0.30 mm glass bead pin, DC to 65 GHz
V103F-012	V(f) flange launcher, 2 mounting holes for 0.30 mm glass bead pin, DC to 65 GHz
V103F-R	V(f) flange launcher connector, DC to 65 GHz, 2 mounting holes
V110-1-R*	Microstrip stress relief contact

\*Sold in multiples of 10 only.

# WI CONNECTOR®

DC to 110 GHz



The WI Connector® Family is a complete coaxial connector system with mode-free performance to 110 GHz. Based on the 1.00 mm coaxial connector front side interface as specified by IEEE Std 287, the WI Connector is well suited for high frequency applications ranging from components to systems and instrumentation.

Visit [www.anritsu.com](http://www.anritsu.com) for the latest information including installation instructions, outline drawings, and RoHS compliance status.

## WI Connector® features

- Excellent RF Performance to 110 GHz
- 50 Ω Impedance
- Low VSWR
- Industry Standard 1 mm Interface

## Connector Launchers

The WI Connector® launcher family includes both male and female WI Connectors. The WI Connector® has an air dielectric interface similar to K and V connectors. The center conductor is supported by Anritsu's proprietary low-loss high temperature support bead on one end and a glass bead (W1-102F and W1-102M) or a Teflon bead (W1-105F and W1-105M) on the other end. The use of the high temperature support bead allows the connector to be subjected to temperature ranges up to 200°C for a short period. The center

conductor extends outside of the connector and allows the user to make a direct pin overlap connection to the microwave circuit. The threads on the backside of the WI Connector® allow the user to install the WI Connector® by screwing it into the housing wall. Since Anritsu's proprietary low-loss high temperature plastic bead is used, the user can solder the connector which has the glass bead into the housing to achieve a hermetic connection.

## Flange Mount Connector

W1 two-hole Flange Mount female Connector is also available. The center conductor of the connector is supported by a PPO® bead on the front-end and by a Teflon bead on the back end. The center conductor extends outside the connector, allowing for a direct pin overlap connection to the microwave circuit.

## Cable Connector

Both the male and female cable connectors are available. Typical return loss at 110 GHz for finished cables exceeds 16 dB (1.35 SWR).

## Tools



**01-504, WI-6 mm**  
Torque Wrench



**01-506, WI-7 mm**  
Torque Wrench



**01-505, WI-6-7 mm**  
Open end Wrench

## Connectors



**W1-101M**  
W1 Male In-line Cable Connector, DC-110 GHz



**W1-101F**  
W1 Female In-line Cable Connector, DC-110 GHz



**W1-102M, W1-105M**  
W1 Male Sparkplug Connector, DC-110 GHz

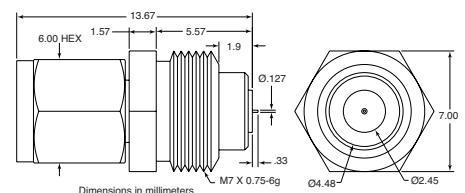
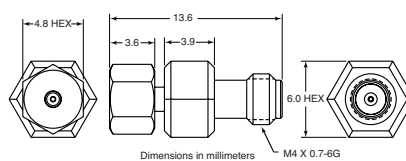
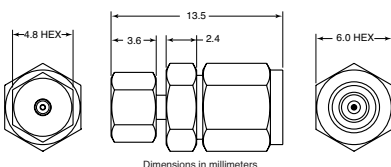

① Use with 01-506 Torque Wrench

# WI CONNECTOR®

DC to 110 GHz



**W1-102F, W1-105F<sup>Ⓞ</sup>**  
W1 Female Sparkplug  
Connector, DC-110 GHz

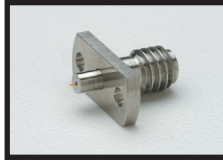

**W1-103F**  
W1 Female Flange  
Connector, DC-110 GHz



**W047-2**  
Semi-rigid coaxial cable,  
1.52 m length of 1.19  
mm semi-rigid cable for  
W1-101 series connector

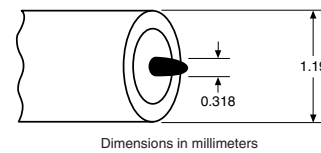
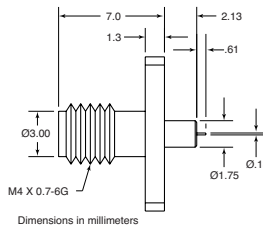
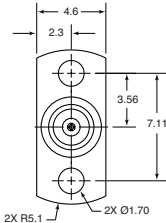
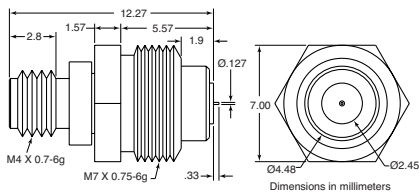

## Specifications

<b>Impedance</b>	50 Ω
<b>Frequency</b>	DC to 110 GHz
<b>Insertion Loss</b>	0.70 dB typical
<b>Return Loss</b>	1.38 to 110 GHz typical 1.24 to 110 GHz typical (W1-101F, W1-101M)
<b>Insulation Resistance</b>	>1200 MΩ
<b>Center Conductor Contact Resistance</b>	6 mΩ typical
<b>Maximum Power CW</b>	6 W
<b>Frontside Pin Depth</b>	0 to 0.076 mm maximum
<b>Backside Pin Protrusion</b>	0.33 mm typical for W1-102F, W1-102M, W1-105F, W1-105M, 0.61 mm typical for W1-103F
<b>Torque Coupling Nut</b>	4 in-lb maximum
<b>Torque W1 Connector Installation</b>	5 in-lb maximum
<b>Hermeticity (W1-102F, W1-102M)</b>	1 x 10 <sup>-8</sup> std cc He/sec at atmosphere differential

## Materials

<b>W1-101F W1-101M</b>	Outer Conductor: Passivated Stainless Steel Center Conductor: Beryllium-copper, gold plated over nickel per Mil-G-45204C Coupling Nut: Passivated Stainless Steel Sleeve: Beryllium-copper, gold plated over nickel per Mil-G-45204C Lock Screw: Passivated Stainless Steel
<b>W1-102F W1-102M</b>	Outer Conductor: Beryllium-copper, gold plated over nickel per Mil-G-45204C Center Conductor: Beryllium-copper, gold plated over nickel per Mil-G-45204C Coupling Nut: Passivated Stainless Steel Glass Bead Center Pin: Kovar, gold plated over nickel per Mil-G-45204C Glass Bead Outer Conductor: Kovar, gold plated over nickel per Mil-G-45204C Glass Bead Dielectric: Corning 7070 Glass Plastic Bead Dielectric: Proprietary
<b>W1-103F</b>	Outer Conductor: Passivated stainless steel Center Conductor: Beryllium-copper, gold plated over nickel per Mil-G-45204C Coupling Nut: Passivated Stainless Steel Plastic Support Bead Dielectric: Polyphenylene Oxide Noryl
<b>W1-105F W1-105M</b>	Outer Conductor: Passivated stainless steel Center Conductor: Beryllium-copper, gold plated over nickel per Mil-G-45204C Coupling Nut: Passivated Stainless Steel Plastic Support Bead Dielectric: Proprietary

## Environmental information

Tests are performed per MIL-STD-202F.

<b>Operating Temperature Range</b>	0° to +55°C
<b>Storage Temperature Range</b>	-54° to +125°C for W1-102F, W1-102M, W1-105F, W1-105M -54° to +85°C for W1-103F
<b>Humidity</b>	25° to -40° and 25° to 125°C, method 107G, condition B
<b>Shock</b>	100G peak sawtooth, method 213, test condition 1
<b>Vibration</b>	Sinewave: 10 Hz to 2000 Hz, 0.06" DA, method 204, test condition D Random: 50 Hz to 2000 Hz, 11.6 Grams, Power Spectral Density 0.1 Grams <sup>2</sup> /Hz, Method 214, Test Condition 1, Letter D
<b>Salt Spray</b>	5% concentration for 48 hours, Method 101D, Condition B
<b>Dielectric Withstanding Voltage</b>	500 Vac RMS, 60 seconds, method 301

## Ordering information

Please specify model/order number, name, and quantity when ordering.

Model/Order No.	Name
W1-101F	W1 Male In-line Cable Connector, DC-110 GHz
W1-101M	W1 Female In-line Cable Connector, DC-110 GHz
W1-102F	W1 Female Sparkplug Connector, Hermetic, DC-110 GHz
W1-102M	W1 Male Sparkplug Connector, Hermetic, DC-110 GHz
W1-103F	W1 Female Flange Connector, DC-110 GHz
W1-105F	W1 Female Sparkplug Connector, DC-110 GHz
W1-105M	W1 Male Sparkplug Connector, DC-110 GHz
W047-2	Semi-rigid Coaxial Cable
01-504	W1 6 mm Torque Wrench
01-505	W1 6-7mm Open end Wrench
01-506	W1 7 mm Torque Wrench

<sup>Ⓞ</sup> Use with 01-506 Torque Wrench

# 0.8 MM CONNECTOR

## DC to 145 GHz

The 0.8 mm Connector Family is a complete coaxial connector system that can propagate frequencies within a coaxial transmission line with mode-free performance to 145 GHz. Based on the 0.8 mm coaxial connector front side interface as specified by IEEE Std 287, the 0.8 mm Connector is ideally suited for high frequency applications ranging from optic and millimeter wave components to systems and instrumentation.

### 0.8 mm Connector features

- Excellent performance to 145 GHzz
- 50 Ω impedance
- Low VSWR
- Industry Standard 0.8 mm Interface
- Supports the VectorStar 145 GHz broadband system

### 0.8 mm Connector

The 0.8 mm connector is a pin and socket type connector which uses an air dielectric interface. High performance support beads are used and are set back far enough from the reference plane so that interaction between beads in a connector pair is minimized. The connectors physical and mechanical dimensions were chosen to maximize strength, increase durability, and provide highly repeatable interconnects. Since these characteristics were desired, this connector does not mate with any other size connector such as the 1 mm. The coupling engagement of the outer conductors was designed to ensure the outer conductors are coupled before the inner conductors can engage, thus guaranteeing a damage free connection.

### Specifications

Impedance	50 W
Frequency	DC to 145 GHz
Insertion Loss	0.70 dB typical
Return Loss	1.50 to 110 GHz typical 1.67 to 145 GHz typical (0.8-105M, 0.8-105F)
Insulation Resistance	>1200 MΩ
Center Conductor Contact Resistance	6 mΩ typical
Maximum Power CW	6 W
Frontside Pin Depth	0 to -0.076 mm maximum
Backside Pin Protrusion	0.29 mm typical for 0.8-105M, 0.8-105F
Torque Coupling Nut	4 in-lb maximum
Torque 0.8 mm Connector Installation	5 in-lb maximum

### Environmental information

Tests are performed per MIL-STD-202F.

Operating Temperature Range	0° to +55°C
Storage Temperature Range	-54° to +125°C for 0.8-105M, 0.8-105F
Humidity	25° to -40° and 25° to 125°C, method 107G, condition B
Shock	100G peak sawtooth, method 213, test condition 1
Vibration	Sinewave: 10 Hz to 2000 Hz, 0.06" DA, method 204, test condition D Random: 50 Hz to 2000 Hz, 11.6 Grams, Power Spectral Density 0.1 Grams <sup>2</sup> /Hz, Method 214, Test Condition 1, Letter D
Salt Spray	5% concentration for 48 hours, Method 101D, Condition B
Dielectric Withstanding Voltage	500 Vac RMS, 60 seconds, method 301

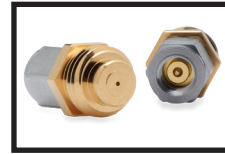

**0.8 mm-105M**  
0.8 mm Male Sparkplug Connector

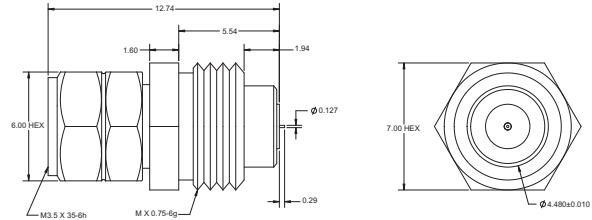

**0.8 mm-105M**  
0.8 mm Female Sparkplug Connector

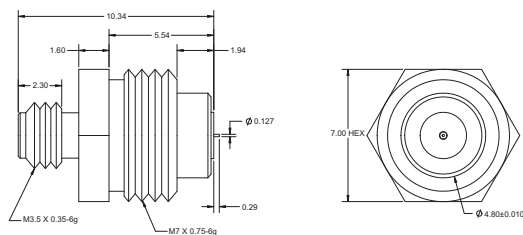

### Tools



**01-524, 0.8 mm-6 mm**  
Torque Wrench



**01-525, 0.8 mm-6x7 mm**  
Open End Wrench

### Materials

0.8-105F, 0.8-105M	Outer Conductor: Beryllium-copper, gold plated over nickel per Mil-G-45204C Center Conductor: Beryllium-copper, gold plated over nickel per Mil-G-45204C Coupling Nut: Passivated Stainless Steel Sleeve: Beryllium-copper, gold plated over nickel per Mil-G-45204C Lock Screw: Passivated Stainless Steel Plastic Support Bead Dielectric: Proprietary
--------------------	--

### Ordering information

Please specify model/order number, name, and quantity when ordering.

Model/Order No.	Name
0.8-105M	0.8 mm Male Sparkplug Launch Connector, DC-145 GHz
0.8-105F	0.8 mm Female Sparkplug Launch Connector, DC-145 GHz
01-506	0.8 mm 7mm Torque Wrench (FYI for installing conn into housing)
01-524	0.8 mm 6mm TorqueWrench
01-525	0.8 mm 6x7 mm Open End Wrench

# RF CABLES

K120, V120 DC to 65 GHz



## Semi-rigid RF cable features

- Up to 65 GHz frequency ranges
- Type N, K Connector®, and V Connector®
- K Connector® compatibility with SMA and 3.5 mm
- V Connector® compatibility with 2.4 mm

## Specifications

Model	Frequency range (GHz)	Impedance (Ω)	Length	Connectors
N120-6	DC to 18	50	15 cm	N(m) - N(m)
NS120MF-6	DC to 18	50	15 cm	N(m) - SMA(f)
K120MM	DC to 40	50	See table	K(m) - K(m)
K120MF	DC to 40	50	See table	K(m) - K(f)
K120FF	DC to 40	50	See table	K(f) - K(f)
V120MM	DC to 65	50	See table	V(m) - V(m)
V120MF	DC to 65	50	See table	V(m) - V(f)
V120FF	DC to 65	50	See table	V(f) - V(f)

Temperature range: -55°C to +125°C

Contact Anritsu Company for low loss, low VSWR cable bending services.

## Semi-rigid coaxial cable specifications for V Connectors®

Type	Semi-rigid coaxial, tin-plated copper outer conductor, silver-plated copper center conductor.
Impedance	50 ± 2 Ω
Dielectric type	Microporous PTFE
Dielectric constant	1.687
Relative velocity	0.78
Outside diameter	2.18 mm
Center conductor diameter	0.51 mm
Minimum bend radius	1.0 cm
Attenuation	2.3 dB/m at 10 GHz 3.6 dB/m at 20 GHz 4.3 dB/m at 30 GHz 5.2 dB/m at 40 GHz 7.2 dB/m at 60 GHz

## Semi-rigid coaxial cable specifications for K Connectors®

Type	Semi-rigid coaxial, tin or tin/bismuth plated copper outer conductor, silver-plated copper center conductor.
Impedance	50 ± 2 Ω
Dielectric type	Microporous PTFE
Dielectric constant	1.687
Relative velocity	0.78
Outside diameter	2.95 mm
Center conductor diameter	0.81 mm
Minimum bend radius	1.3 cm
Attenuation	1.6 dB/m at 10 GHz 2.3 dB/m at 20 GHz 3.3 dB/m at 30 GHz 4.7 dB/m at 40 GHz
K118 semirigid coaxial cable	1.52 m length of 2.95 mm Semirigid cable for K101 series connector

# RF CABLES

K120, V120 DC to 65 GHz

## Cable assembly part number reference

Length	Metric cable assemblies					
	K120MM	K120MF	K120FF	V120MM	V120MF	V120FF
5	K120MM-5CM	K120MF-5CM	K120FF-5CM	V120MM-5CM	V120MF-5CM	V120FF-5CM
10	K120MM-10CM	K120MF-10CM	K120FF-10CM	V120MM-10CM	V120MF-10CM	V120FF-10CM
15	K120MM-15CM	K120MF-15CM	K120FF-15CM	V120MM-15CM	V120MF-15CM	V120FF-15CM
20	K120MM-20CM	K120MF-20CM	K120FF-20CM	V120MM-20CM	V120MF-20CM	V120FF-20CM
25	K120MM-25CM	K120MF-25CM	K120FF-25CM	V120MM-25CM	V120MF-25CM	V120FF-25CM
30	K120MM-30CM	K120MF-30CM	K120FF-30CM	V120MM-30CM	V120MF-30CM	V120FF-30CM
35	K120MM-35CM	K120MF-35CM	K120FF-35CM	V120MM-35CM	V120MF-35CM	V120FF-35CM
40	K120MM-40CM	K120MF-40CM	K120FF-40CM	V120MM-40CM	V120MF-40CM	V120FF-40CM
45	K120MM-45CM	K120MF-45CM	K120FF-45CM	V120MM-45CM	V120MF-45CM	V120FF-45CM
50	K120MM-50CM	K120MF-50CM	K120FF-50CM	V120MM-50CM	V120MF-50CM	V120FF-50CM
60	K120MM-60CM	K120MF-60CM	K120FF-60CM	V120MM-60CM	V120MF-60CM	V120FF-60CM
70	K120MM-70CM	K120MF-70CM	K120FF-70CM	V120MM-70CM	V120MF-70CM	V120FF-70CM
80	K120MM-80CM	K120MF-80CM	K120FF-80CM	V120MM-80CM	V120MF-80CM	V120FF-80CM
90	K120MM-90CM	K120MF-90CM	K120FF-90CM	V120MM-90CM	V120MF-90CM	V120FF-90CM
100	K120MM-100CM	K120MF-100CM	K120FF-100CM	V120MM-100CM	V120MF-100CM	V120FF-100CM
125	K120MM-125CM	K120MF-125CM	K120FF-125CM	V120MM-125CM	V120MF-125CM	V120FF-125CM
150	K120MM-150CM	K120MF-150CM	K120FF-150CM	V120MM-150CM	V120MF-150CM	V120FF-150CM



*K120FF outline*

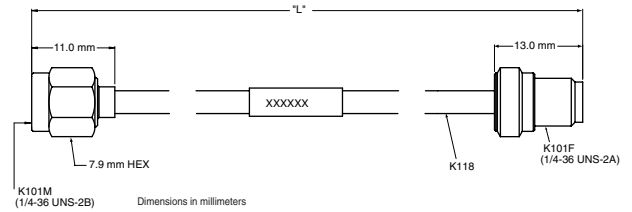

*K120MF outline*

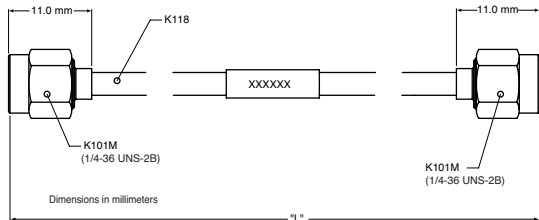

*K120MM outline*

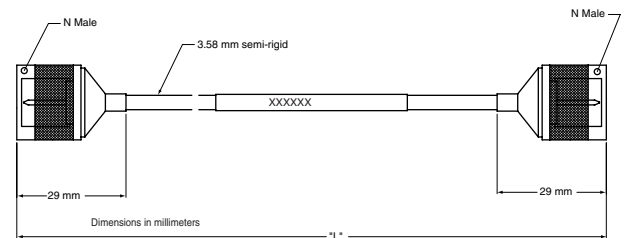

*N120-6 outline*

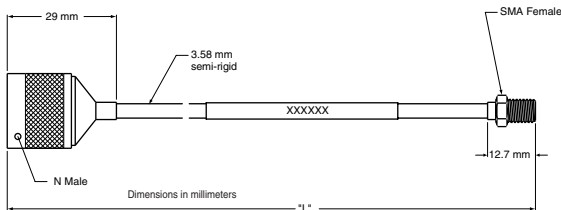

*NS120MF-6 outline*

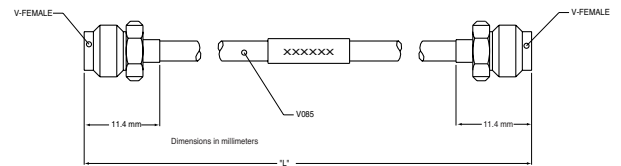

*V120FF outline*

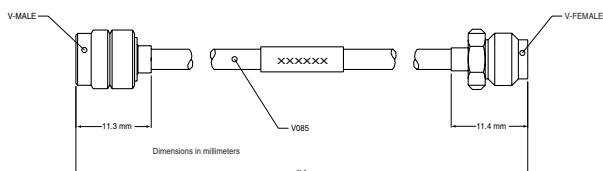

*V120MF outline*

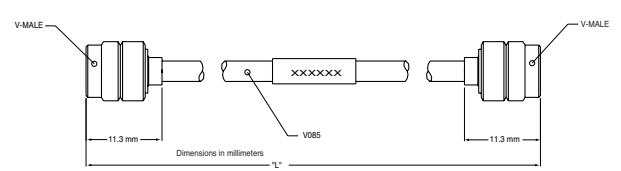

*V120MM outline*

# RF CABLES

K120, V120 DC to 65 GHz

## Ordering information

Please specify model/order number, name and quantity when ordering.

Model/Order No.	Name
	<b>Cable, semi-rigid</b>
N120-6	DC to 18 GHz, 50 Ω, 15 cm, N(m) to N(m)
NS120MF-6	DC to 18 GHz, 50 Ω, 15 cm, N(m) to SMA(f)
K120MM-5CM	DC to 40 GHz, 50 Ω, 5 cm, K(m) to K(m)
K120MM-10CM	DC to 40 GHz, 50 Ω, 10 cm, K(m) to K(m)
K120MM-15CM	DC to 40 GHz, 50 Ω, 15 cm, K(m) to K(m)
K120MM-20CM	DC to 40 GHz, 50 Ω, 20 cm, K(m) to K(m)
K120MM-25CM	DC to 40 GHz, 50 Ω, 25 cm, K(m) to K(m)
K120MM-30CM	DC to 40 GHz, 50 Ω, 30 cm, K(m) to K(m)
K120MM-35CM	DC to 40 GHz, 50 Ω, 35 cm, K(m) to K(m)
K120MM-40CM	DC to 40 GHz, 50 Ω, 40 cm, K(m) to K(m)
K120MM-45CM	DC to 40 GHz, 50 Ω, 45 cm, K(m) to K(m)
K120MM-50CM	DC to 40 GHz, 50 Ω, 50 cm, K(m) to K(m)
K120MM-60CM	DC to 40 GHz, 50 Ω, 60 cm, K(m) to K(m)
K120MM-70CM	DC to 40 GHz, 50 Ω, 70 cm, K(m) to K(m)
K120MM-80CM	DC to 40 GHz, 50 Ω, 80 cm, K(m) to K(m)
K120MM-90CM	DC to 40 GHz, 50 Ω, 90 cm, K(m) to K(m)
K120MM-100CM	DC to 40 GHz, 50 Ω, 100 cm, K(m) to K(m)
K120MM-125CM	DC to 40 GHz, 50 Ω, 125 cm, K(m) to K(m)
K120MM-150CM	DC to 40 GHz, 50 Ω, 150 cm, K(m) to K(m)
K120MF-5CM	DC to 40 GHz, 50 Ω, 5 cm, K(m) to K(f)
K120MF-10CM	DC to 40 GHz, 50 Ω, 10 cm, K(m) to K(f)
K120MF-15CM	DC to 40 GHz, 50 Ω, 15 cm, K(m) to K(f)
K120MF-20CM	DC to 40 GHz, 50 Ω, 20 cm, K(m) to K(f)
K120MF-25CM	DC to 40 GHz, 50 Ω, 25 cm, K(m) to K(f)
K120MF-30CM	DC to 40 GHz, 50 Ω, 30 cm, K(m) to K(f)
K120MF-35CM	DC to 40 GHz, 50 Ω, 35 cm, K(m) to K(f)
K120MF-40CM	DC to 40 GHz, 50 Ω, 40 cm, K(m) to K(f)
K120MF-45CM	DC to 40 GHz, 50 Ω, 45 cm, K(m) to K(f)
K120MF-50CM	DC to 40 GHz, 50 Ω, 50 cm, K(m) to K(f)
K120MF-60CM	DC to 40 GHz, 50 Ω, 60 cm, K(m) to K(f)
K120MF-70CM	DC to 40 GHz, 50 Ω, 70 cm, K(m) to K(f)
K120MF-80CM	DC to 40 GHz, 50 Ω, 80 cm, K(m) to K(f)
K120MF-90CM	DC to 40 GHz, 50 Ω, 90 cm, K(m) to K(f)
K120MF-100CM	DC to 40 GHz, 50 Ω, 100 cm, K(m) to K(f)
K120MF-125CM	DC to 40 GHz, 50 Ω, 125 cm, K(m) to K(f)
K120MF-150CM	DC to 40 GHz, 50 Ω, 150 cm, K(m) to K(f)
K120FF-5CM	DC to 40 GHz, 50 Ω, 5 cm, K(f) to K(f)
K120FF-10CM	DC to 40 GHz, 50 Ω, 10 cm, K(f) to K(f)
K120FF-15CM	DC to 40 GHz, 50 Ω, 15 cm, K(f) to K(f)
K120FF-20CM	DC to 40 GHz, 50 Ω, 20 cm, K(f) to K(f)
K120FF-25CM	DC to 40 GHz, 50 Ω, 25 cm, K(f) to K(f)
K120FF-30CM	DC to 40 GHz, 50 Ω, 30 cm, K(f) to K(f)
K120FF-35CM	DC to 40 GHz, 50 Ω, 35 cm, K(f) to K(f)
K120FF-40CM	DC to 40 GHz, 50 Ω, 40 cm, K(f) to K(f)
K120FF-45CM	DC to 40 GHz, 50 Ω, 45 cm, K(f) to K(f)
K120FF-50CM	DC to 40 GHz, 50 Ω, 50 cm, K(f) to K(f)
K120FF-60CM	DC to 40 GHz, 50 Ω, 60 cm, K(f) to K(f)
K120FF-70CM	DC to 40 GHz, 50 Ω, 70 cm, K(f) to K(f)
K120FF-80CM	DC to 40 GHz, 50 Ω, 80 cm, K(f) to K(f)
K120FF-90CM	DC to 40 GHz, 50 Ω, 90 cm, K(f) to K(f)
K120FF-100CM	DC to 40 GHz, 50 Ω, 100 cm, K(f) to K(f)
K120FF-125CM	DC to 40 GHz, 50 Ω, 125 cm, K(f) to K(f)
K120FF-150CM	DC to 40 GHz, 50 Ω, 150 cm, K(f) to K(f)

Model/Order No.	Name
	<b>Cable, semi-rigid</b>
V120MM-5CM	DC to 65 GHz, 50 Ω, 5 cm, V(m) to V(m)
V120MM-10CM	DC to 65 GHz, 50 Ω, 10 cm, V(m) to V(m)
V120MM-15CM	DC to 65 GHz, 50 Ω, 15 cm, V(m) to V(m)
V120MM-20CM	DC to 65 GHz, 50 Ω, 20 cm, V(m) to V(m)
V120MM-25CM	DC to 65 GHz, 50 Ω, 25 cm, V(m) to V(m)
V120MM-30CM	DC to 65 GHz, 50 Ω, 30 cm, V(m) to V(m)
V120MM-35CM	DC to 65 GHz, 50 Ω, 35 cm, V(m) to V(m)
V120MM-40CM	DC to 65 GHz, 50 Ω, 40 cm, V(m) to V(m)
V120MM-45CM	DC to 65 GHz, 50 Ω, 45 cm, V(m) to V(m)
V120MM-50CM	DC to 65 GHz, 50 Ω, 50 cm, V(m) to V(m)
V120MM-60CM	DC to 65 GHz, 50 Ω, 60 cm, V(m) to V(m)
V120MM-70CM	DC to 65 GHz, 50 Ω, 70 cm, V(m) to V(m)
V120MM-80CM	DC to 65 GHz, 50 Ω, 80 cm, V(m) to V(m)
V120MM-90CM	DC to 65 GHz, 50 Ω, 90 cm, V(m) to V(m)
V120MM-100CM	DC to 65 GHz, 50 Ω, 100 cm, V(m) to V(m)
V120MM-125CM	DC to 65 GHz, 50 Ω, 125 cm, V(m) to V(m)
V120MM-150CM	DC to 65 GHz, 50 Ω, 150 cm, V(m) to V(m)
V120MF-5CM	DC to 65 GHz, 50 Ω, 5 cm, V(m) to V(f)
V120MF-10CM	DC to 65 GHz, 50 Ω, 10 cm, V(m) to V(f)
V120MF-15CM	DC to 65 GHz, 50 Ω, 15 cm, V(m) to V(f)
V120MF-20CM	DC to 65 GHz, 50 Ω, 20 cm, V(m) to V(f)
V120MF-25CM	DC to 65 GHz, 50 Ω, 25 cm, V(m) to V(f)
V120MF-30CM	DC to 65 GHz, 50 Ω, 30 cm, V(m) to V(f)
V120MF-35CM	DC to 65 GHz, 50 Ω, 35 cm, V(m) to V(f)
V120MF-40CM	DC to 65 GHz, 50 Ω, 40 cm, V(m) to V(f)
V120MF-45CM	DC to 65 GHz, 50 Ω, 45 cm, V(m) to V(f)
V120MF-50CM	DC to 65 GHz, 50 Ω, 50 cm, V(m) to V(f)
V120MF-60CM	DC to 65 GHz, 50 Ω, 60 cm, V(m) to V(f)
V120MF-70CM	DC to 65 GHz, 50 Ω, 70 cm, V(m) to V(f)
V120MF-80CM	DC to 65 GHz, 50 Ω, 80 cm, V(m) to V(f)
V120MF-90CM	DC to 65 GHz, 50 Ω, 90 cm, V(m) to V(f)
V120MF-100CM	DC to 65 GHz, 50 Ω, 100 cm, V(m) to V(f)
V120MF-125CM	DC to 65 GHz, 50 Ω, 125 cm, V(m) to V(f)
V120MF-150CM	DC to 65 GHz, 50 Ω, 150 cm, V(m) to V(f)
V120FF-5CM	DC to 65 GHz, 50 Ω, 5 cm, V(f) to V(f)
V120FF-10CM	DC to 65 GHz, 50 Ω, 10 cm, V(f) to V(f)
V120FF-15CM	DC to 65 GHz, 50 Ω, 15 cm, V(f) to V(f)
V120FF-20CM	DC to 65 GHz, 50 Ω, 20 cm, V(f) to V(f)
V120FF-25CM	DC to 65 GHz, 50 Ω, 25 cm, V(f) to V(f)
V120FF-30CM	DC to 65 GHz, 50 Ω, 30 cm, V(f) to V(f)
V120FF-35CM	DC to 65 GHz, 50 Ω, 35 cm, V(f) to V(f)
V120FF-40CM	DC to 65 GHz, 50 Ω, 40 cm, V(f) to V(f)
V120FF-45CM	DC to 65 GHz, 50 Ω, 45 cm, V(f) to V(f)
V120FF-50CM	DC to 65 GHz, 50 Ω, 50 cm, V(f) to V(f)
V120FF-60CM	DC to 65 GHz, 50 Ω, 60 cm, V(f) to V(f)
V120FF-70CM	DC to 65 GHz, 50 Ω, 70 cm, V(f) to V(f)
V120FF-80CM	DC to 65 GHz, 50 Ω, 80 cm, V(f) to V(f)
V120FF-90CM	DC to 65 GHz, 50 Ω, 90 cm, V(f) to V(f)
V120FF-100CM	DC to 65 GHz, 50 Ω, 100 cm, V(f) to V(f)
V120FF-125CM	DC to 65 GHz, 50 Ω, 125 cm, V(f) to V(f)
V120FF-150CM	DC to 65 GHz, 50 Ω, 150 cm, V(f) to V(f)

# ARMORED SEMI-RIGID TEST PORT CABLES

3670 Series DC to 145 GHz



The 3670 series cables are laboratory quality cables that contain General Precision Connectors. These cables are used to connect VNA Test Sets to the device under test (DUT). They are also used to connect to a 3680 Universal Test Fixture or other test interface devices.

## Features:

- Up to 145 GHz frequency range
- Type GPC-7, N, K Connector®, and V Connector®, and 0.8 mm Precision Connectors
- Excellent return loss performance



## Specifications

Model	Frequency Range (GHz)	Impedance (Ω)	Connector Types	Length (Feet)	Return Loss
3670A50-2	DC to 18	50	GPC-7	2	17 dB
3670N50-1	DC to 18	50	N(m)-N(f)	1	17 dB
3670N50-2	DC to 18	50	N(m)-N(f)	2	
3670NN50-1	DC to 18	50	N(m)-N(m)	1	17 dB
3670NN50-2	DC to 18	50	N(m)-N(m)	2	
3670K50-1	DC to 40	50	K(m)-K(f)	1	16 dB
3670K50-2	DC to 40	50	K(m)-K(f)	2	
3670V50A-1	DC to 70	50	V(m)-V(f)	1	16 dB
3670V50A-2	DC to 70	50	V(m)-V(f)	2	
3670.850-1	DC to 145	50	0.8(m)-0.8(f)	10 cm	10 dB*
3670.850-2	DC to 145	50	0.8(m)-0.8(f)	16 cm	

\*Typical

## Ordering information

Please specify model/order number, name, and quantity when ordering.

Model/Order No.	Name
3670A50-2	GPC-7, 2 Foot
3670N50-1	N(m) - N(f), 1 Foot
3670N50-2	N(m) - N(f), 2 Foot
3670NN50-1	N(m)-N(m), 1 Foot
3670NN50-2	N(m)-N(m), 2 Foot
3670K50-1	K(m)-K(f), 1 Foot
3670K50-2	K(m)-K(f), 2 Foot
3670V50A-1	V(m)-V(f), 1 Foot
3670V50A-2	V(m)-V(f), 2 Foot
3670.850-1	0.8 mm(m)-0.8 mm(f), 10 cm
3670.850-2	0.8 mm(m)-0.8 mm(f), 16 cm



# COAXIAL ADAPTERS

K, V, K to V DC to 65 GHz



The K220 and 34V Series of precision adapters enable accurate measurements with K or V connectors. Every adapter is fully specified and 100% tested to ensure low reflections and optimum performance over the DC to 65 GHz range.

## Precision K and V adapter features

- K Connector® DC to 40 GHz frequency range
- V Connector® DC to 65 GHz frequency range
- Low SWR and insertion loss

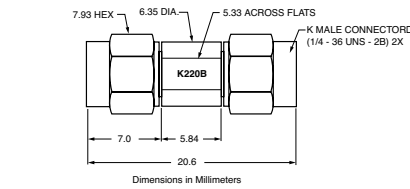

K220B outline

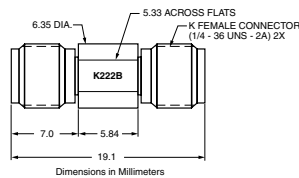

K222B outline

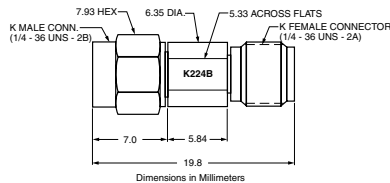

K224B outline

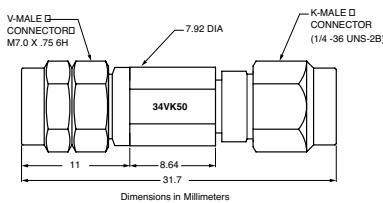

34VK50 outline

## Specifications

Model	Frequency range (GHz)	Connectors	SWR
K220B K222B K224B	DC to 40	K(m) to K(m) K(f) to K(f) K(f) to K(m)	1.12
34VK50 34VKF50	DC to 40	V(m) to K(m) V(m) to K(f)	1.3
34VFK50 34VFKF50	DC to 40	V(f) to K(m) V(f) to K(f)	1.3
34VV50 34VVF50 34VVF50	DC to 65	V(m) to V(m) V(f) to V(f) V(m) to V(f)	1.5

Temperature range: -55°C to +125°C

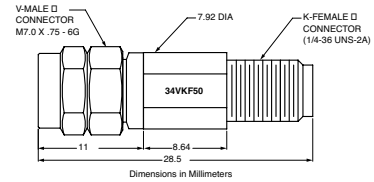

34VKF50 outline

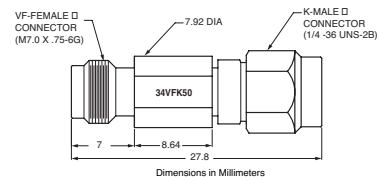

34VFK50 outline

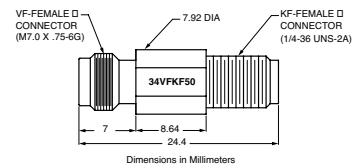

34VFKF50 outline

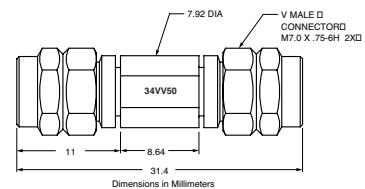

34VV50 outline

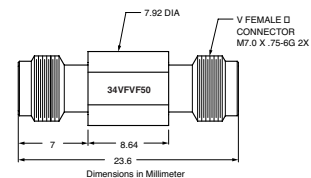

34VVF50 outline

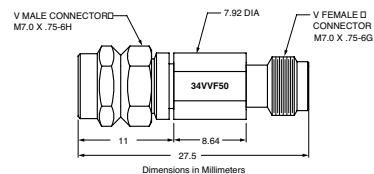

34VVF50 outline

# COAXIAL ADAPTERS

K, V, K to V DC to 65 GHz

The K230 Series is the panel-mount version of the K220 Series Adapters. These units mount in a standard 9.5 mm “D” hole.

## K and V panel adapter features

- Precision, panel-mounted feedthru adapter
- Broad, DC to 65 GHz frequency range

## K panel adapter specifications

Model	Frequency range (GHz)	Connectors	SWR
K230B	DC to 40	K(m) to K(m)	1.12
K232B		K(f) to K(f)	
K234B		K(f) to K(m)	

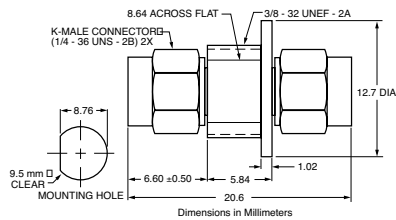

K230B outline

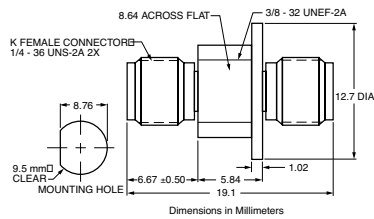

K232B outline

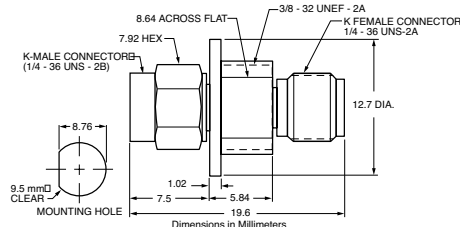

K234B outline

## Electrical Length

Series	Inch	cm	picosecond
K22XB	0.629	1.598	53.26
34VK50	1.112	2.824	94.123
34VKF50	0.922	2.342	78.07
34VFK50	0.922	2.341	78.03
34VFKF50	0.732	1.860	62.00
34VV50	1.125	2.857	95.23
34VVF50	0.745	1.892	63.07
34VVF50	0.935	2.374	79.13

## V panel adapter specifications

Model	Frequency range (GHz)	Connectors	SWR
V230	DC to 65	V(m) to V(m)	1.5
V232		V(f) to V(f)	
V234		V(f) to V(m)	

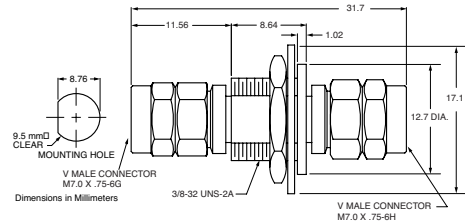

V230 outline

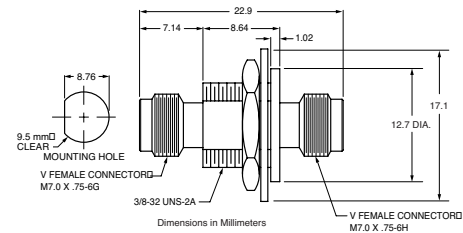

V232 outline

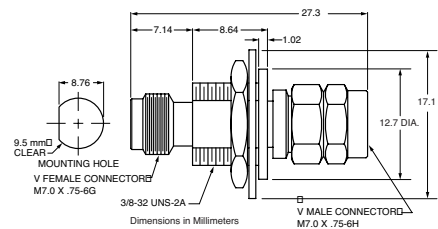

V234 outline

## Ordering information

Please specify model/order number, name and quantity when ordering.

Model/Order No.	Name
	<b>Precision adapter</b>
K220B	DC to 40 GHz, 50 Ω, K(m)-K(m)
K222B	DC to 40 GHz, 50 Ω, K(f)-K(f)
K224B	DC to 40 GHz, 50 Ω, K(m)-K(f)
K230B	DC to 40 GHz, 50 Ω, K(m)-K(m)
K232B	DC to 40 GHz, 50 Ω, K(f)-K(f)
K234B	DC to 40 GHz, 50 Ω, K(f)-K(m)
34VK50	DC to 40 GHz, 50 Ω, V(m)-K(m)
34VKF50	DC to 40 GHz, 50 Ω, V(m)-K(f)
34VFK50	DC to 40 GHz, 50 Ω, V(f)-K(m)
34VFKF50	DC to 40 GHz, 50 Ω, V(f)-K(f)
34VV50	DC to 65 GHz, 50 Ω, V(m)-V(m)
34VVF50	DC to 65 GHz, 50 Ω, V(m)-V(f)
34VVF50	DC to 65 GHz, 50 Ω, V(f)-V(f)
V230	DC to 65 GHz, 50 Ω, V(m)-V(m)
V232	DC to 65 GHz, 50 Ω, V(f)-V(f)
V234	DC to 65 GHz, 50 Ω, V(f)-V(m)

# CALIBRATION GRADE ADAPTERS

## 33 Series DC to 145 GHz

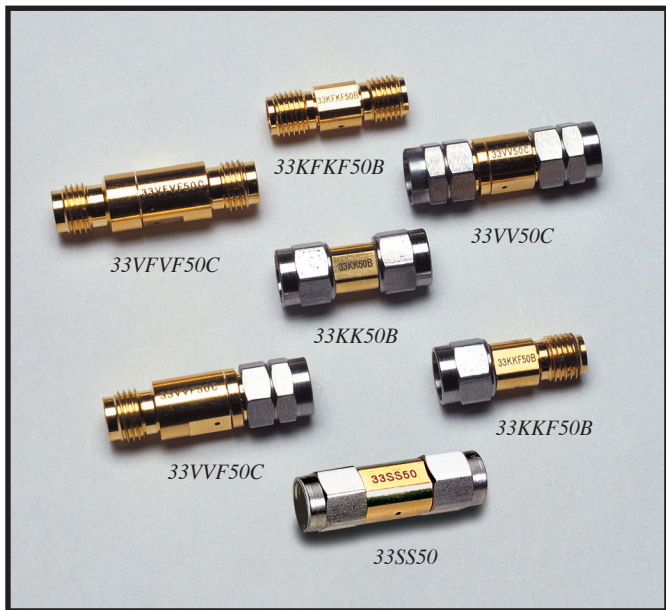

The 33 Series of precision phase equal adapters enable accurate measurements with Anritsu V Connector®, K Connector®, W1 Connector®, 0.8 mm Connector, WSMA, and Type N interfaces. Every adapter is fully specified and 100% tested to ensure low reflections and optimum phase performance over a broad frequency range.

### Features

- Low SWR and insertion loss
- DC to 145 GHz, with 0.8 mm Connector interface
- DC to 110 GHz, with W1 Connector® interface
- DC to 70 GHz, with V Connector® interface
- DC to 40 GHz, with K Connector® interface
- 50 Ω impedance

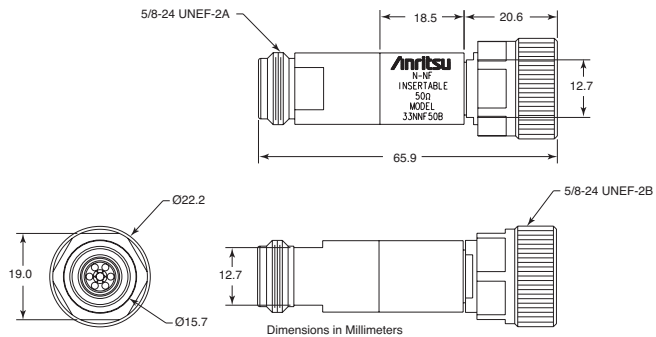

33NNF50B outline

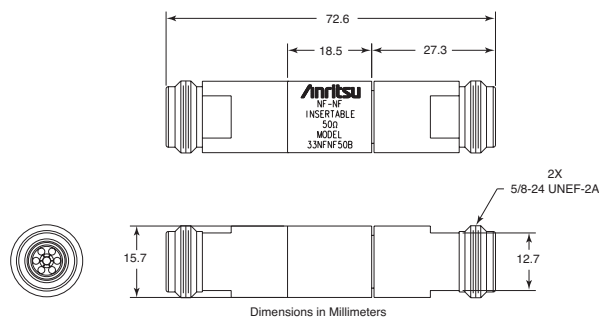

33NKF50B outline

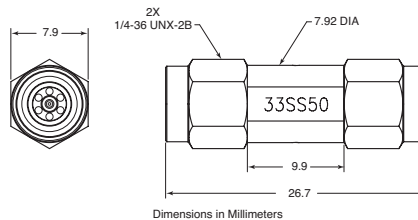

33SS50 outline

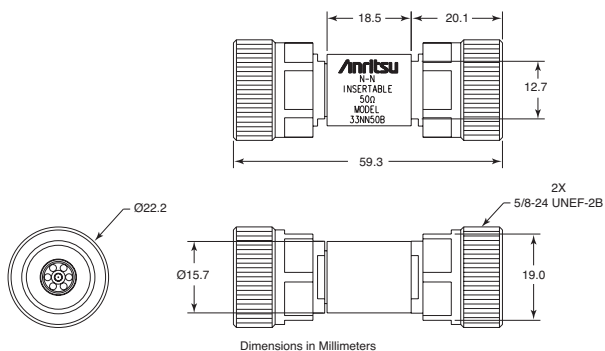

33NN50B outline

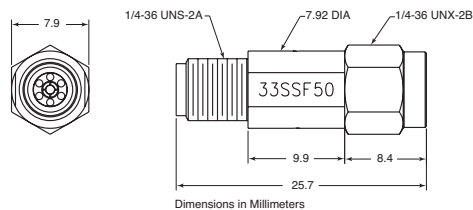

33SSF50 outline

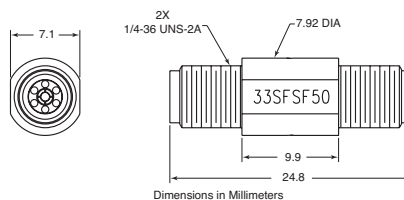

33SFSF50 outline

# CALIBRATION GRADE ADAPTERS

## 33 Series DC to 145 GHz

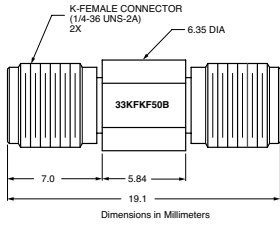

33KFKF50B outline

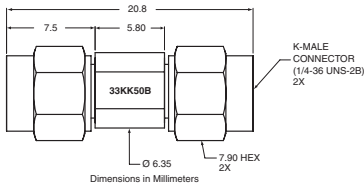

33KK50B outline

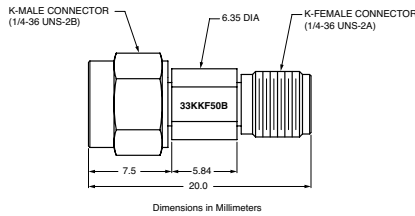

33KKF50B outline

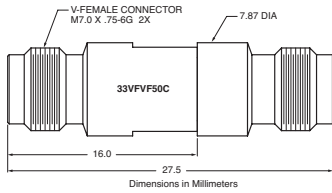

33VVF50C outline

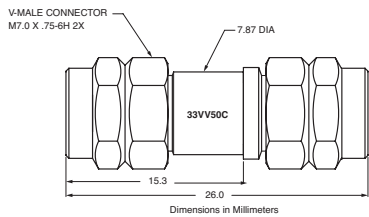

33VV50C outline

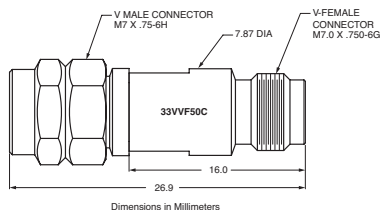

33VVF50C outline



**33WW50**  
Precision W1 Male to W1 Male Adapter,  
DC to 110 GHz

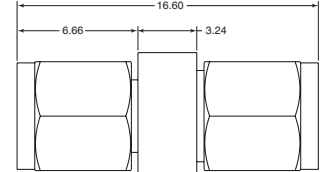
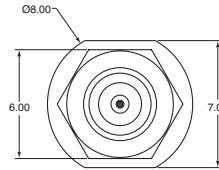

Dimensions in Millimeters



**33WWF50**  
Precision W1 Male to W1 Female Adapter,  
DC to 110 GHz

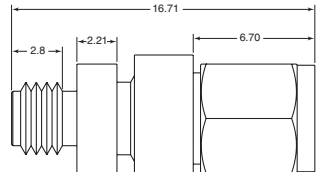
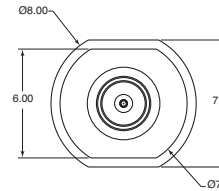

Dimensions in Millimeters



**33WFWF50**  
Precision W1 Female to W1 Female Adapter,  
DC to 110 GHz

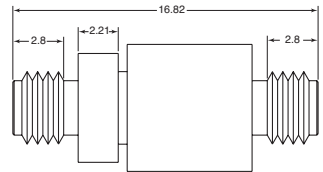
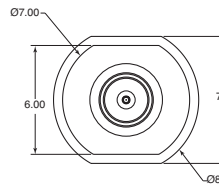

Dimensions in Millimeters

# CALIBRATION GRADE ADAPTERS

## 33 Series DC to 145 GHz

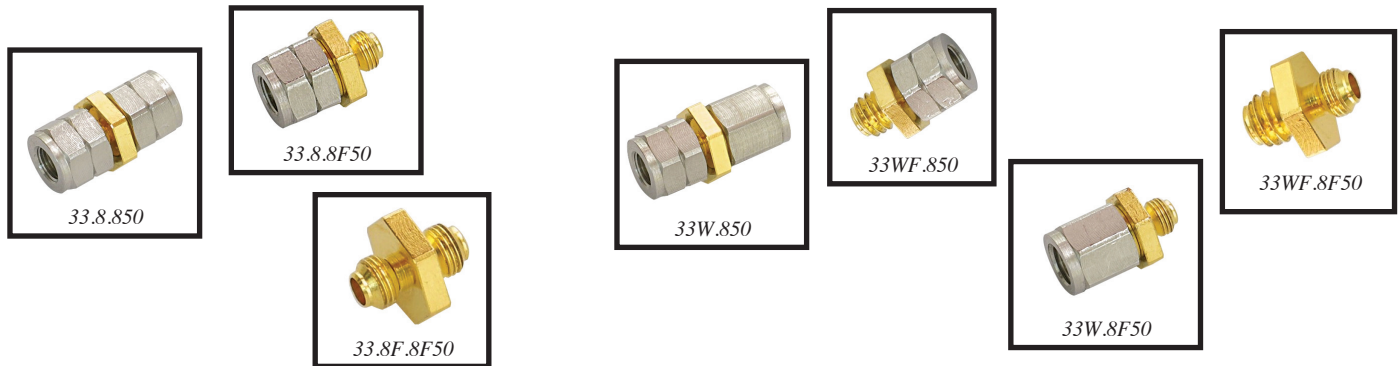

### 0.8 mm In-Series Adapters

The 33 series precision 0.8 mm Adapters enable accurate measurements with Anritsu 0.8 mm connectors at a broad frequency range of up to 145 GHz. The 33 series 0.8 mm – 0.8 mm adapters are available in three connector sex configurations: (male – male), (male – female), and (female – female). 0.8 mm adapters have an air dielectric interface and a center conductor that is supported by a proprietary low-loss high temperature support bead. When used as connector savers, these adapters protect the system’s test port by reducing the number of connections made directly to the test port.

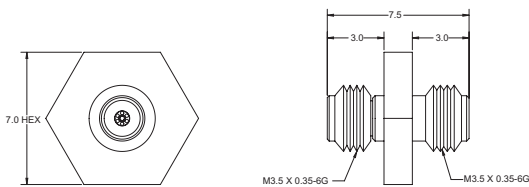

Precision 0.8 mm Female to Female Adapter (33.8F.8F50)

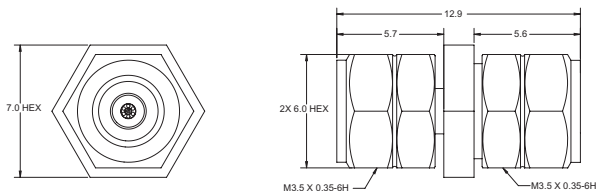

Precision 0.8 mm Male to 0.8 mm Male Adapter (33.8.850)

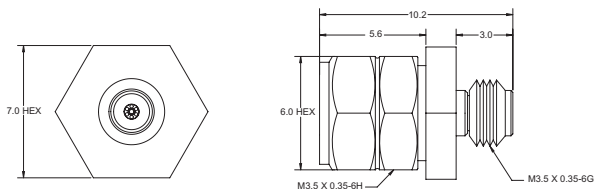

Precision 0.8 mm Male to 0.8 mm Female Adapter (33.8F.850)

### 0.8 mm Waveguide Adapters and 0.8 mm-W1 Adapters

The precision 0.8 mm waveguide adapters transform standard WR10 and WR8 waveguide interfaces to precision coaxial 0.8 mm connector interfaces, thus enabling convenient millimeter wave coaxial measurements. Please contact Anritsu for more details on this product.

0.8 mm – W1 adapters provide an interface between 0.8 mm connectors and W1 connectors and allow connections between two different connector types. Please contact Anritsu for more details on this product. [www.anritsu.com](http://www.anritsu.com)

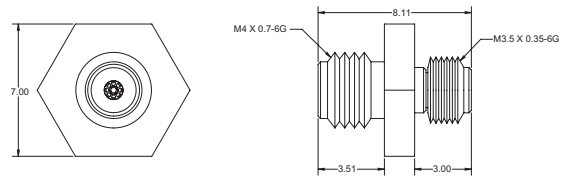

W1 Female to 0.8 mm Female Adapter (33WF.8F50)

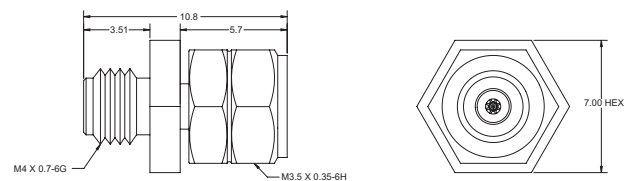

W1 Female to 0.8 mm Male Adapter (33WF.850)

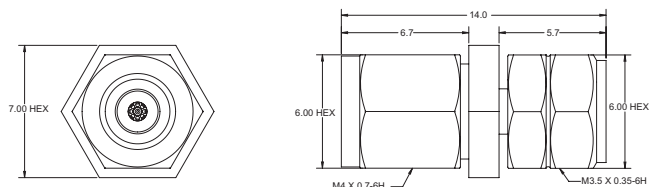

W1 Male to 0.8 mm Male Adapter (33W.850)

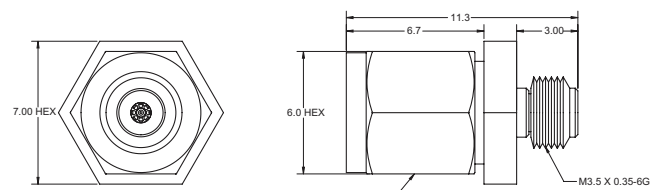

W1 Male to 0.8 mm Female Adapter (33W.8F50)

# CALIBRATION GRADE ADAPTERS

## 33 Series DC to 145 GHz

### Specifications

Model	Frequency range (GHz)	Impedance(Ω)	Connectors	SWR
33NN50B	DC to 18	50	N(m)-N(m)	1.09
33NNF50B	DC to 18	50	N(m)-N(f)	1.09
33NFN50B	DC to 18	50	N(f)-N(f)	1.09
33SS50	DC to 26.5	50	WSMA(m)-WSMA(m)	1.08 to 18 GHz 1.12 to 26.5 GHz
33SSF50	DC to 26.5	50	WSMA(m)-WSMA(f)	1.08 to 18 GHz 1.12 to 26.5 GHz
33SFSF50	DC to 26.5	50	WSMA(f)-WSMA(f)	1.08 to 18 GHz 1.12 to 26.5 GHz
33KK50B	DC to 40	50	K(m)-K(m)	1.1
33KKF50B	DC to 40	50	K(m)-K(f)	1.1
33KFKF50B	DC to 40	50	K(f)-K(f)	1.1
33VV50C	DC to 70	50	V(m)-V(m)	1.33
33VVF50C	DC to 70	50	V(m)-V(f)	1.33
33VVF50C	DC to 70	50	V(f)-V(f)	1.33
33WW50	DC to 110	50	W1(m)-W1(m)	1.17 to 40 GHz 1.29 to 65 GHz 1.38 to 110 GHz
33WWF50	DC to 110	50	W1(m)-W1(f)	1.17 to 40 GHz 1.29 to 65 GHz 1.38 to 110 GHz
33WFWF50	DC to 110	50	W1(f)-W1(f)	1.17 to 40 GHz 1.29 to 65 GHz 1.38 to 110 GHz
33W.850*	DC to 110	50	W1(m)-0.8 mm(m)	1.17 to 65 GHz 1.29 to 80 GHz 1.43 to 110 GHz
33W.8F50*	DC to 110	50	W1(m)-0.8 mm(f)	1.17 to 65 GHz 1.29 to 80 GHz 1.43 to 110 GHz
33WF.850*	DC to 110	50	W1(f)-0.8 mm(m)	1.17 to 65 GHz 1.29 to 80 GHz 1.43 to 110 GHz
33WF.8F50*	DC to 110	50	W1(f)-0.8 mm(f)	1.17 to 65 GHz 1.29 to 80 GHz 1.43 to 110 GHz
33.8.850*	DC to 145	50	0.8 mm(m)-0.8 mm(m)	1.15 to 40 GHz 1.22 to 80 GHz 1.29 to 110 GHz 1.43 to 145 GHz
33.8.8F50*	DC to 145	50	0.8 mm(m)-0.8 mm(f)	1.15 to 40 GHz 1.22 to 80 GHz 1.29 to 110 GHz 1.43 to 145 GHz
33.8.F8F50*	DC to 145	50	0.8 mm(f)-0.8 mm(f)	1.15 to 40 GHz 1.22 to 80 GHz 1.29 to 110 GHz 1.43 to 145 GHz

**Temperature range:** -55°C to +125°C

\*SWR Specifications are Typical

### Electrical Length

Series	Inch	cm	picosecond
33K	0.623	1.582	52.75
33N	2.292	5.822	194.06
33S	0.855	2.172	72.39
33V B/C	0.93	2.362	78.74
33W	0.55	1.397	46.57
33.8.F50	0.318	0.808	26.93
33.8F.8F50	0.207	0.526	17.54
33.8.850	0.426	1.082	36.05
33WF.850	0.328	0.833	27.76
33WF.8F50	0.22	0.558	18.61
33W.8F50	0.351	0.893	29.75
33W.850	0.459	1.167	38.9

### Ordering information

Please specify model/order number, name and quantity when ordering.

Model/Order No.	Name
	<b>Calibration grade adapter</b>
33NN50B	DC to 18 GHz, 50 Ω, N(m)-N(m)
33NNF50B	DC to 18 GHz, 50 Ω, N(m)-N(f)
33NFN50B	DC to 18 GHz, 50 Ω, N(f)-N(f)
33SS50	DC to 26.5 GHz, 50 Ω, WSMA(m)-WSMA(m)
33SSF50	DC to 26.5 GHz, 50 Ω, WSMA(m)-WSMA(f)
33SFSF50	DC to 26.5 GHz, 50 Ω, WSMA(f)-WSMA(f)
33KFKF50B	DC to 40 GHz, 50 Ω, K(f)-K(f)
33KK50B	DC to 40 GHz, 50 Ω, K(m)-K(m)
33KKF50B	DC to 40 GHz, 50 Ω, K(m)-K(f)
33VVF50C	DC to 70 GHz, 50 Ω, V(f)-V(f)
33VV50C	DC to 70 GHz, 50 Ω, V(m)-V(m)
33VVF50C	DC to 70 GHz, 50 Ω, V(m)-V(f)
33WW50	DC to 110 GHz, 50 Ω, W1(m)-W1(m)
33WWF50	DC to 110 GHz, 50 Ω, W1(m)-W1(f)
33WFWF50	DC to 110 GHz, 50 Ω, W1(f)-W1(f)
33W.850	DC to 110 GHz, 50 Ω, W1(m)-0.8 mm(m)
33W.8F50	DC to 110 GHz, 50 Ω, W1(m)-0.8 mm(f)
33WF.850	DC to 110 GHz, 50 Ω, W1(f)-0.8 mm(m)
33WF.8F50	DC to 110 GHz, 50 Ω, W1(f)-0.8 mm(f)
33.8.850	DC to 145 GHz, 50 Ω, 0.8 mm(m)-0.8 mm(m)
33.8.8F50	DC to 145 GHz, 50 Ω, 0.8 mm(m)-0.8 mm(f)
33.8F.8F50	DC to 145 GHz, 50 Ω, 0.8 mm(f)-0.8 mm(f)

# INSTRUMENTATION GRADE ADAPTERS

## 34 Series DC to 60 GHz



The 34 Series of precision adapters enable accurate measurements with GPC-7, Type N, or WSMA interfaces. Every adapter is fully specified and 100% tested to ensure low reflections and optimum performance over a broad frequency range.

### Precision adapter features

- Low SWR and insertion loss
- GPC-7, Type N, and WSMA connectors
- Convenient transition with minimal effect on signal
- 50 Ω or 75 Ω impedance

### Specifications

Model	Frequency range (GHz)	Impedance (Ω)	Connectors	SWR	Dimensions L(cm) x dia(cm)
34NN75B	DC to 3	75	N(m) to N(m)	1.1	6.0 x 2.2
34AN50 34ANF50	DC to 18	50	GPC-7 to N(m) GPC-7 to N(f)	1.02	4.2 x 2.2 4.2 x 2.2
34NN50A 34NFN50	DC to 18	50	N(m) to N(m) N(f) to N(f)	1.1	6.0 x 2.2 4.7 x 1.6
34NK50 34NKF50 34NFK50 34NFKF50	DC to 18	50	N(m) to K(m) N(m) to K(f) N(f) to K(m) N(f) to K(f)	1.12	3.8 x 2.2 3.8 x 2.2 3.8 x 1.6 3.8 x 1.6

The 34R Series precision adapters provide a rugged, rigid connection between Anritsu instruments with WSMA, K Connector®, or V Connector® outputs and Anritsu SWR Autotesters and SWR Bridges or other instruments.

The adapters have an outside diameter equal to that of a Type N connector, adding mechanical strength to the test setup and making installation convenient and fast.

### Specifications

Model	Frequency range (GHz)	Connectors	SWR	Dimensions L(cm) x dia(cm)
34RSN50	DC to 18	WSMA(m) to N(m)		
34AKNF50	DC to 20	RAK(m) to N(f)		
34RKNF50	DC to 18	RK(m) to N(f)	1.40	5.1 x 1.7
34RVNF50	DC to 18	RV(m) to N(f)	1.40	5.1 x 1.7
34RKRK50	DC to 40	RK(m) to RK(m)	2.00	5.8 x 1.7
34RVRK50	DC to 40	RV(m) to RK(m)	2.00	5.8 x 1.7
34RVRV50	DC to 60	RV(m) to RV(m)	2.30	5.8 x 1.7

Impedance: 50 Ω

Temperature range: 0°C to +75°C

### Ruggedized adapter features

- Enhance reliability of microwave test setup
- Easy-to-grasp Type N outside diameter
- Rigid test connections for improved test data repeatability

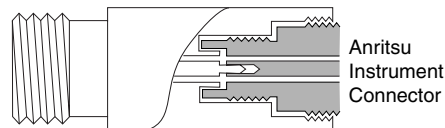

34R Series Adapter

### Ordering information

Please specify model/order number, name, and quantity when ordering.

Model/Order No.	Name
	<b>Precision adapter</b>
34NN75B	DC to 3 GHz, 75 Ω, N(m)-N(m)
34AN50	DC to 18 GHz, 50 Ω, GPC-7-N(m)
34ANF50	DC to 18 GHz, 50 Ω, GPC-7-N(f)
34AKNF50	DC to 20 GHz, 50 Ω, RAK(m)-N(f)
34NN50A	DC to 18 GHz, 50 Ω, N(m)-N(m)
34NFN50	DC to 18 GHz, 50 Ω, N(f)-N(f)
34NK50	DC to 18 GHz, 50 Ω, N(m)-K(m)
34NKF50	DC to 18 GHz, 50 Ω, N(m)-K(f)
34NFK50	DC to 18 GHz, 50 Ω, N(f)-K(m)
34NFKF50	DC to 18 GHz, 50 Ω, N(f)-K(f)
34RSN50	DC to 18 GHz, 50 Ω, WSMA(m)-N(m)
34RKNF50	DC to 18 GHz, 50 Ω, RK(m) to N(f)
34RVNF50	DC to 18 GHz, 50 Ω, RV(m) to N(f)
34RKRK50	DC to 40 GHz, 50 Ω, RK(m) to RK(m)
34RVRK50	DC to 40 GHz, 50 Ω, RV(m) to RK(m)
34RVRV50	DC to 60 GHz, 50 Ω, RV(m) to RV(m)

# INSTRUMENTATION GRADE ADAPTERS

## 34 Series W to V DC to 65 GHz

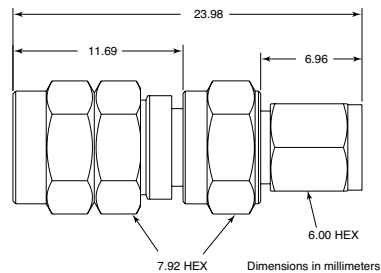

34WV50 outline

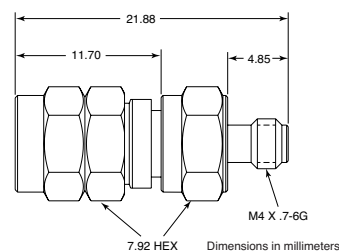

34WV50 outline

These 34 Series of precision adapters enable accurate measurement with W1 Connector® and V Connector® interfaces.

### Precision adapter features

- Low SWR and insertion loss
- W1 and V Connector<sup>s</sup>®
- 50 Ω Impedance

### Specifications

Model	Frequency Range (GHz)	Impedance (Ω)	Connectors	Insertion Loss	SWR
34WV50	DC to 65 GHz	50	W1(m) to V(m)	0.5 dB	1.22
34WV50	DC to 65 GHz	50	W1(f) to V(m)	0.5 dB	1.22
34WV50	DC to 65 GHz	50	W1(m) to V(f)	0.5 dB	1.22
34WV50	DC to 65 GHz	50	W1(f) to V(f)	0.5 dB	1.22

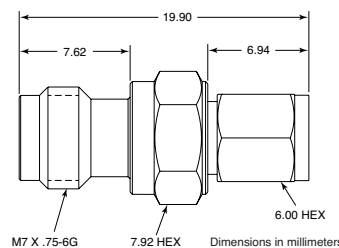

34WV50 outline

### Ordering information

Please specify model/order number, name, and quantity when ordering.

Model/Order No.	Name
	Precision adapter
34WV50	DC to 65 GHz, 50 Ω, W1(m) to V(m)
34WV50	DC to 65 GHz, 50 Ω, W1(f) to V(m)
34WV50	DC to 65 GHz, 50 Ω, W1(m) to V(f)
34WV50	DC to 65 GHz, 50 Ω, W1(f) to V(f)

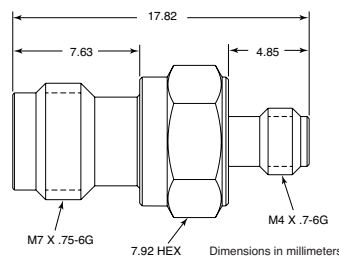

34WV50 outline



# INSTRUMENTATION GRADE WAVEGUIDE ADAPTERS

## 35WR Series 18 to 110 GHz

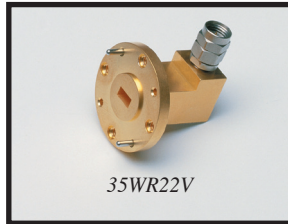

The 35 Series precision adapters transform standard or double-ridge waveguide to coaxial K Connector® and V Connector®, and W1 Connector®, interfaces, thus enabling convenient millimeter wave coaxial measurements.

### Features

- 18 to 65 GHz frequency coverage
- K Connector® compatibility with SMA and 3.5 mm
- V Connector® compatibility with 2.4 mm
- W1 Connector® compatibility with 1.0 mm
- Standard and double-ridge designs

### Specifications

Model	Frequency range (GHz)	Connectors	W/G flange	SWR
35WRD180K 35WRD180KF	18 to 40	WRD180 to K(m) WRD180 to K(f)	N/A	1.25
35WR42K 35WR42KF	18 to 26.5	WR42 to K(m) WR42 to K(f)	595	1.25
35WR28K 35WR28KF	26.5 to 40	WR28 to K(m) WR28 to K(f)	599	1.25
35WR22K 35WR22KF	33 to 50	WR22 to K(m) WR22 to K(f)	383	1.30
35WR22V 35WR22VF	33 to 50	WR22 to V(m) WR22 to V(f)	383	1.30
35WR19K 35WR19KF	40 to 50 Usable to 54	WR19 to K(m) WR19 to K(f)	383	1.30
35WR19V 35WR19VF	40 to 60	WR19 to V(m) WR19 to V(f)	383	1.30
35WR15V 35WR15VF	50 to 65	WR15 to V(m) WR15 to V(f)	385	1.30
35WR10W 35WR10WF	75 to 110	WR10 to W1(m) WR10 to W1(f)	387	1.38

Impedance: 50 Ω

Temperature range: -55°C to +125°C

### Ordering information

Please specify model/order number, name, and quantity when ordering.

Model/Order No.	Name
	<b>Precision waveguide to coax adapter</b>
35WRD180K	18 to 40 GHz, WRD180 (double ridge waveguide) to K(m)
35WRD180KF	18 to 40 GHz, WRD180 (double ridge waveguide) to K(f)
35WR42K	18 to 26.5 GHz, WR42-K(m)
35WR42KF	18 to 26.5 GHz, WR42-K(f)
35WR28K	26.5 to 40 GHz, WR28-K(m)
35WR28KF	26.5 to 40 GHz, WR28-K(f)
35WR22K	33 to 50 GHz, WR22-K(m)
35WR22KF	33 to 50 GHz, WR22-K(f)
35WR22V	33 to 50 GHz, WR22-V(m)
35WR22VF	33 to 50 GHz, WR22-V(f)
35WR19K	40 to 50 GHz (usable to 54 GHz), WR19-K(m)
35WR19KF	40 to 50 GHz (usable to 54 GHz), WR19-K(f)
35WR19V	40 to 60 GHz, WR19-V(m)
35WR19VF	40 to 60 GHz, WR19-V(f)
35WR15V	50 to 65 GHz (usable to 67 GHz), WR15-V(m)
35WR15VF	50 to 65 GHz (usable to 67 GHz), WR15-V(f)
35WR10W	75 to 110, WR10 to W1(m)
35WR10WF	75 to 110, WR10 to W1(f)

Outline drawings for the 35 Series Waveguide-to-Coaxial Adapters, 18 to 110 GHz, are shown on the following three pages.

# INSTRUMENTATION GRADE WAVEGUIDE ADAPTERS

35WR Series 18 to 110 GHz

## Outline Drawings

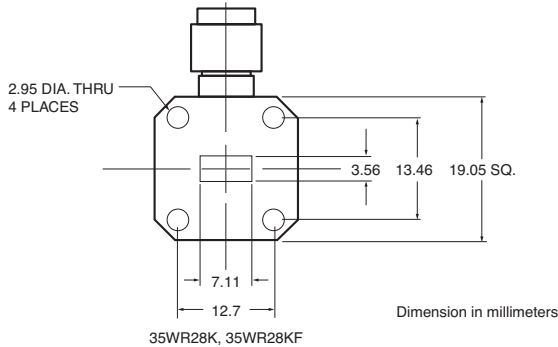
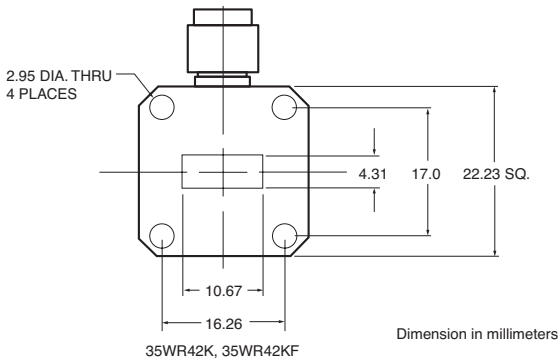
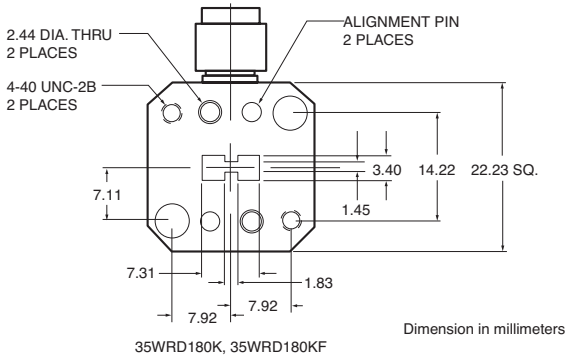
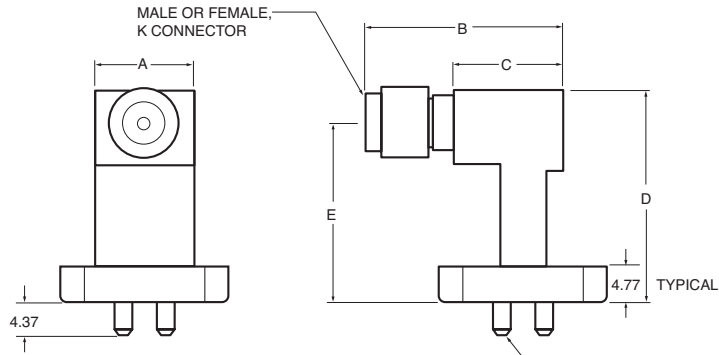

Model	Dimensions (mm)				
	A	B	C	D	E
35WRD180K	13.20	27.9	14.43	28.40	23.80
35WRD180KF	13.20	22.9	14.43	28.40	23.80
35WR42K	13.20	27.9	14.43	28.14	23.93
35WR42KF	13.20	22.9	14.43	28.14	23.93
35WR28K	10.67	27.9	14.86	28.78	23.93
35WR28KF	10.67	22.9	14.86	28.78	23.88

35WRD180K, 35WRD180KF, 35WR42K, 35WR42KF, 35WR28K, 35WR28KF outlines

# INSTRUMENTATION GRADE WAVEGUIDE ADAPTERS

35WR Series 18 to 110 GHz

## Outline Drawings

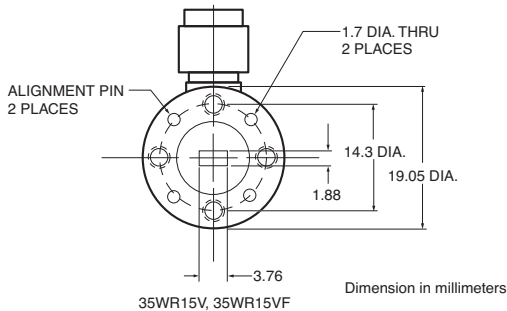
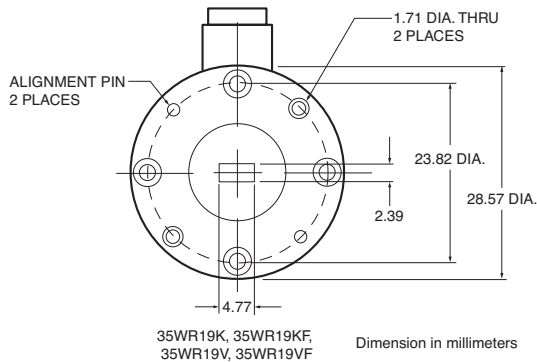
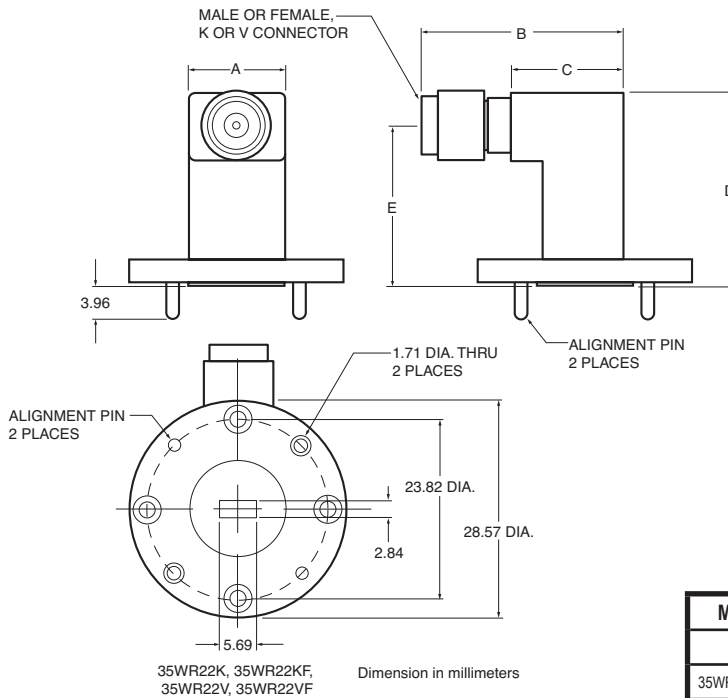

Model	Dimensions (mm)				
	A	B	C	D	E
35WR22K	12.70	26.9	14.73	25.76	21.44
35WR22KF	12.70	21.6	14.73	25.76	21.44
35WR22V	12.70	26.9	14.73	25.76	21.44
35WR22VF	12.70	21.6	14.73	25.76	21.44
35WR19K	12.70	26.9	14.73	25.76	21.44
35WR19KF	12.70	21.6	14.73	25.76	21.44
35WR19V	12.70	27.9	14.73	25.76	21.44
35WR19VF	12.70	22.6	14.73	25.76	21.44
35WR15V	12.70	24.4	12.19	26.97	21.62
35WR15VF	12.70	20.3	12.19	26.97	21.62

35WR22K, 35WR22KF, 35WR22V, 35WR22VF, 35WR19K, 35WR19KF, 35WR19V, 35WR19VF, 35WR15V, and 35WR15VF outlines

# INSTRUMENTATION GRADE WAVEGUIDE ADAPTERS

35WR Series 18 to 110 GHz

## Outline Drawings

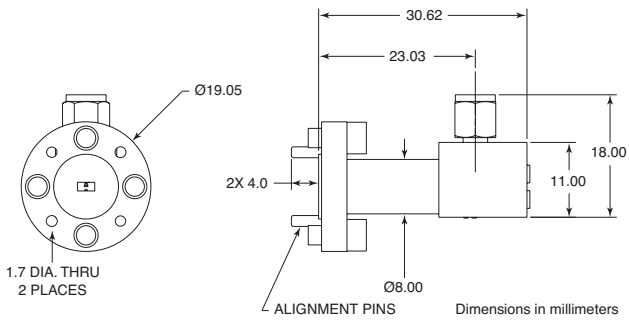

35WR10W outline

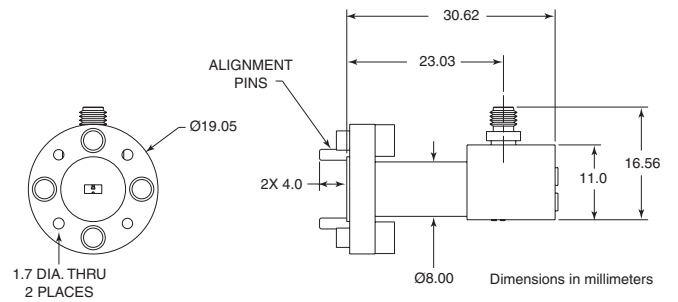

35WR10WF outline

# COAXIAL TERMINATIONS

26/28 Series DC to 145 GHz

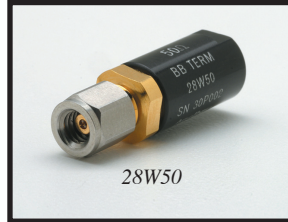

These precision, metrology-grade terminations are used in measurement systems that need to achieve the smallest possible reflections. Their excellent match makes them ideal as a reference for fault location measurements on scalar network analyzers.

## Precision termination features

- Accurate reference for SWR measurements
- Precise termination for test instrument or device under test

## Precision termination specifications

Model	Frequency range (GHz)	Test port connector	Input impedance ( $\Omega$ )	SWR (F in GHz)	Dimensions L(cm) x dia(cm)
26N75A	DC to 3 GHz	N(m)	75		
26NF75A	DC to 3 GHz	N(f)	75		
28L50R	DC to 9	WSMA(m)	50	1.016 to 6 GHz 1.025 to 9 GHz	3.7 x 1.2
28LF50R	DC to 9	WSMA(f)	50	1.016 to 6 GHz 1.025 to 9 GHz	3.7 x 1.2
28A50-1	DC to 18	GPC-7	50	1.02 Max.	5.2 x 2.2
28N50-2	DC to 18	N(m)	50	1.02 Max.	5.2 x 2.2
28NF50-2	DC to 18	N(f)	50	1.02 Max.	4.8 x 1.6
28N50-3	DC to 8	N(m)	50	1.03 Max.	5.2 x 2.2
28K50A	DC to 40	K(m)	50	1.040 to 20 GHz	3.7 x 1.2
28KF50A	DC to 40	K(f)	50	1.052 to 40 GHz	3.7 x 1.2
28V50D	DC to 70	V(m)	50	1.018 to 2.5 GHz 1.032 to 4 GHz	3.7 x 1.2
28VF50D	DC to 70	V(f)	50	1.052 to 40 GHz 1.083 to 50 GHz 1.106 to 70 GHz	3.7 x 1.2
28W50*	DC to 110	W1(m)	50	1.052 to 20 GHz 1.065 to 65 GHz 1.253 to 90 GHz 1.499 to 110 GHz	2.4 x 0.8
28WF50*	DC to 110	W1(f)	50	1.052 to 20 GHz 1.065 to 65 GHz 1.288 to 90 GHz 1.499 to 110 GHz	2.1 x 0.8
28.850**	DC to 145	0.8 mm(m)	50	1.052 to 40 GHz 1.065 to 80 GHz 1.222 to 145 GHz	2.5 x 0.8
28.8F50**	DC to 145	0.8 mm(f)	50	1.052 to 40 GHz 1.065 to 80 GHz 1.222 to 145 GHz	2.2 x 0.8

Maximum Input Power: 0.5 W

\* SWR Specification are Typical

\*\* Above 65 GHz, SWR Specification are Typical

## Ordering information

Please specify model/order number, name, and quantity when ordering.

Model/Order No.	Name
	<b>Precision termination</b>
26N75A	DC to 3 GHz, N(m)
26NF75A	DC to 3 GHz, N(f)
28L50R	DC to 9 GHz, 3.5 mm(m)
28LF50R	DC to 9 GHz, 3.5 mm(f)
28A50-1	DC to 18 GHz, 50 $\Omega$ , GPC-7
28N50-2	DC to 18 GHz, 40 dB, 50 $\Omega$ , N(m)
28NF50-2	DC to 18 GHz, 40 dB, 50 $\Omega$ , N(f)
28N50-3	DC to 8.6 GHz, 50 $\Omega$ , N(m)
28K50A	DC to 40 GHz, 50 $\Omega$ , K(m)
28KF50A	DC to 40 GHz, 50 $\Omega$ , K(f)
28V50D	DC to 70 GHz, V(m)
28VF50D	DC to 70 GHz, V(f)
28W50	DC to 110 GHz, W1(m)
28WF50	DC to 110 GHz, W1(f)
28.850	DC to 145 GHz, 0.8 mm(m)
28.8F50	DC to 145 GHz, 0.8 mm(f)

# COAXIAL TERMINATIONS

K210, V210 DC to 65 GHz



## Specifications

Model	Frequency Range (GHz)	Test Port Connector	Input Impedance ( $\Omega$ )	SWR
K210	DC to 40	K(m)	50	1.106 to 18 GHz 1.253 to 40 GHz
V210	DC to 65	V(m)	50	1.120 to 18 GHz 1.253 to 26.5 GHz 1.329 to 40 GHz 1.432 to 65 GHz

Maximum Input Power: 0.5W

## Ordering information

Please specify model/order number, name, and quantity when ordering.

Model/Order No.	Name
K210	Coaxial Termination, DC to 40 GHz, K(m)
V210	Coaxial Termination, DC to 65 GHz, V(m)

## Coaxial Termination features

- Accurate reference for SWR measurements
- Precise termination for test instrument or device under test

# FIXED ATTENUATORS

41, 43 Series DC to 60 GHz\*



41V-10



43KC-10



41V-20



43KC-20

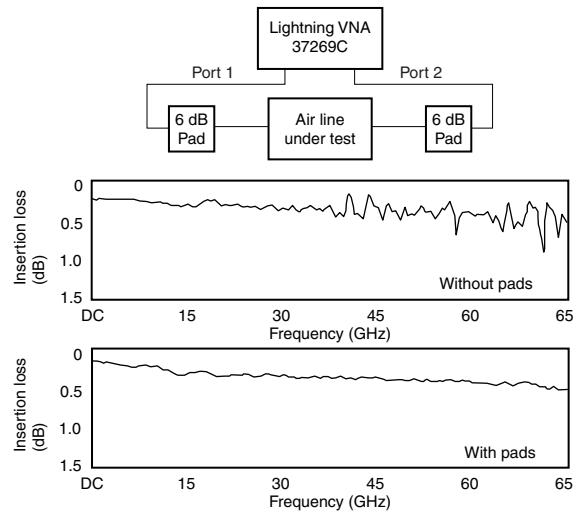

Improved Measurement Accuracy

Anritsu offers two series of fixed attenuators:

- The Gold Line (Series 41) for precision measurement applications covering DC to 60 GHz\*
- The Silver Line (Series 43) for use in systems and OEM equipment covering DC to 40 GHz

Both series offer fixed attenuation values of 3, 6, 10, or 20 dB with models that span frequency range of DC to 26.5 GHz, 40 GHz, or 60 GHz\*

## Features

- 3, 6, 10, or 20 dB Attenuation up to 60 GHz\*
- Low SWR, 1.28 Up to 40 GHz
- SMA, 3.5 mm, and 2.4 mm compatibility
- Rugged and reliable K Connector® and V Connector®

## Advanced performance and reliability

Anritsu attenuators define the standard for fixed attenuator performance and reliability. Performance, however, is not their only distinguishing feature. Attenuators that use the K Connector® offer a vast improvement in reliability, compared to attenuators with SMA connectors. Attenuators that use the V Connector® can be connected directly to 2.4 mm devices.

For applications in metrology and calibration laboratories where precise characterization is essential, the Gold Line models are available in sets consisting of 3, 6, 10, and 20 dB units. Each is provided with attenuation and SWR calibration data. Calibration data is also optionally available for individual units, each of which is serialized.

\*Usable to 70 GHz

The reliability of the attenuator connectors is affected by insertion force, outer conductor mating area, and mating alignment. The K Connector® is used because it has excellent performance in all of these areas. For example, a typical female SMA, 3.5 mm center conductor requires up to 27N\*\* of insertion force compared to 2.2N\*\* for the K Connector®. In addition, the K Connector® outer conductor is four times thicker than SMA, resulting in a conservative order-of-magnitude improvement in the number of reliable connections.

To avoid a major cause of connector failure, the K Connector® male pin is deliberately made shorter than the SMA pin. Therefore, the outer housing is properly aligned prior to center conductor mating, preventing destructive alignment.

## Gold Line - improved measurement accuracy

Adding Gold Line attenuators to your attenuation measurement setup will improve your measurement accuracy. In the test setup shown, the insertion loss of an air line was measured, first without and then with matching 6 dB pads. The difference in the accuracy of the two measurements is striking. By attenuating reflections and re-reflections that occur at the input and output of the air line, the pads reduce mismatch errors and allow the system to measure more accurately the actual insertion loss.

## Silver Line - improved system reliability

Fixed attenuators used in systems or OEM equipment must be small, lightweight, economical, and reliable under severe environmental conditions. The Silver Line meets these requirements. K Connectors ensure well-seated, low-reflection connections that provide consistent operation year after year.

The Series 43 (Silver Line) attenuator's small size, 8 mm dia. x 28.8 mm length, and light weight, 8g make them an attractive choice for miniaturized, lightweight systems.

\*\*Force is measured in Newtons (N).

# FIXED ATTENUATORS

41, 43 Series DC to 60 GHz

## Common specifications

Impedance		50 Ω
Power rating (average)		2W at 20°C; 1W at 85°C
Temperature coefficient		0.001 dB/dB/°C
Connectors	V Connector®	Male and female compatible with 2.4 mm
	K Connector®	Male and female, compatible with SMA and 3.5 mm
Material		Passivated stainless steel housing
Size	Length	28.8 mm ±0.5 mm
	Diameter	8 mm
Weight		8g
Temperature range	Operating	-55°C to +85°C
	Nonoperating	-55°C to +125°C

## Specifications

	Model <sup>①</sup>	Attenuation (dB)	Attenuation Accuracy				SWR					
			DC-18 GHz	18-26.5 GHz	26.5-40 GHz	40-60 GHz	DC-12 GHz	12-18 GHz	18-26.5 GHz	26.5-40 GHz	40-60 GHz	
Gold Line	DC to 60 GHz											
	41V-3	3	±0.5	±0.6	±0.9	±1.50	1.15	1.20	1.30	1.50	1.90	
	41V-6	6	±0.5	±0.6	±0.9	±1.50	1.15	1.20	1.25	1.40	1.90	
	41V-10	10	±0.5	±0.6	±0.9	±1.50	1.15	1.20	1.25	1.40	1.90	
	41V-20	20	±0.5	±0.6	±0.9	±1.50	1.15	1.20	1.25	1.40	1.90	
	DC to 40 GHz											
	41KC-3	3	±0.4	±0.5	±0.8	-	1.10	1.15	1.23	1.42	-	
	41KC-6	6	±0.4	±0.5	±0.8	-	1.10	1.15	1.18	1.28	-	
	41KC-10	10	±0.4	±0.5	±0.8	-	1.10	1.15	1.18	1.28	-	
	41KC-20	20	±0.4	±0.5	±0.8	-	1.10	1.15	1.18	1.28	-	
	DC to 26.5 GHz											
	41KB-3	3	±0.4	±0.5	-	-	1.10	1.15	1.23	-	-	
41KB-6	6	±0.4	±0.5	-	-	1.10	1.15	1.18	-	-		
41KB-10	10	±0.4	±0.5	-	-	1.10	1.15	1.18	-	-		
41KB-20	20	±0.4	±0.5	-	-	1.10	1.15	1.18	-	-		
Silver Line	DC to 40 GHz											
	43KC-3	3	±0.5	±0.6	±0.9	-	1.15	1.20	1.30	1.50	-	
	43KC-6	6	±0.5	±0.6	±0.9	-	1.15	1.20	1.30	1.40	-	
	43KC-10	10	±0.5	±0.6	±0.9	-	1.15	1.20	1.30	1.40	-	
	43KC-20	20	±0.5	±0.6	±0.9	-	1.15	1.20	1.30	1.40	-	
	DC to 26.5 GHz											
	43KB-3	3	±0.5	±0.6	-	-	1.15	1.20	1.30	-	-	
	43KB-6	6	±0.5	±0.6	-	-	1.15	1.20	1.30	-	-	
	43KB-10	10	±0.5	±0.6	-	-	1.15	1.20	1.30	-	-	
	43KB-20	20	±0.5	±0.6	-	-	1.15	1.20	1.30	-	-	

① For traceability, all Gold Line attenuators are serialized.

② ±1 dB from DC to 26.5 GHz; ±1.3 dB from >26.5 to 40 GHz, including frequency response and DC offset.

## Environmental information

Tests are performed per MIL-STD-202F.

Operating Temperature Range	-55°C to +85°
Temperature Shock	-55°C to +150°
Humidity	95% at 40°C, 96 hours, Test 103B, Condition B
Shock	100 G peak sawtooth, method 213, Condition B
Vibration	Sinewave: 10 Hz to 2000 Hz, 0.06" DA, method 204, test condition D
	Random: 50 Hz to 2000 Hz, 11.6 Grms, Power Spectral Density 0.1 Grms 2 Hz, Method 214, Test Condition 1, Letter D
Salt Spray	5% concentration for 48 hours, Method 101D, Condition B
Voltage withstanding	500 Vac RMS, 60 seconds, method 301

## Ordering information

Please specify model/order number, name, and quantity when ordering. Single fixed attenuators may be ordered from the table above.

Model/Order No.	Name
	<b>Precision Fixed Attenuator</b>
41KB-3, 6, 10, or 20	3 dB, 6 dB, 10 dB, 20 dB, DC to 26.5 GHz, 50 Ω, K(m)-K(f)
41KC-3, 6, 10, or 20	3 dB, 6 dB, 10 dB, 20 dB, DC to 40 GHz, 50 Ω, K(m)-K(f)
41V-3, 6, 10, or 20	3 dB, 6 dB, 10 dB, 20 dB, DC to 60 GHz, 50 Ω, V(m)-V(f)
	<b>Precision Fixed Attenuator Set</b>
41KB-S*	41KB Series
41KC-S*	41KC Series
41V-S*	41V Series
	<b>Fixed Attenuator</b>
43KB-3, 6, 10, or 20	3 dB, 6 dB, 10 dB, 20 dB, DC to 26.5 GHz, 50 Ω, K(m)-K(f)
43KC-3, 6, 10, or 20	3 dB, 6 dB, 10 dB, 20 dB, DC to 40 GHz, 50 Ω, K(m)-K(f)
	<b>Option</b>
41K-CAL	Calibration Data for 41K Series Fixed Attenuators
41V-CAL	Calibration Data for 41V Series Fixed Attenuators

\* A set of 3, 6, 10, and 20 dB Gold line (Series 41). Attenuators are supplied in a handsome hardwood case. Calibration data is included for each unit.

\*\* Attenuation and SWR test data are provided for input and output ports at 500 MHz frequency intervals.



# STEP ATTENUATORS

4400, 4500, 4600 Series DC to 40 GHz

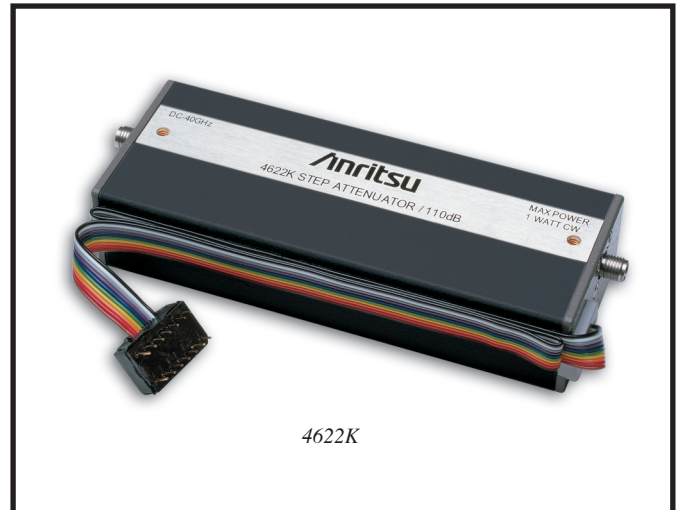
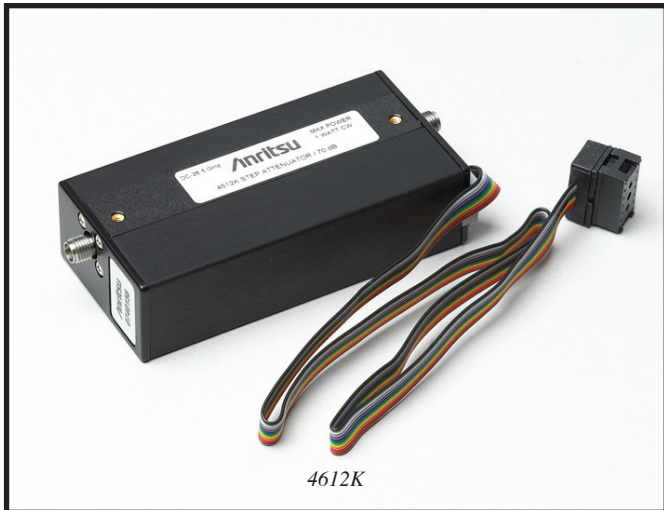

Anritsu programmable step attenuators bring a substantial increase in the frequency and attenuation range available in one small package. Using the latest technology, these units offer superior performance, reliability, and ease of use to 40 GHz. All are plug-compatible with competitive units.

## Features

- DC-20 GHz, DC-26.5 GHz, DC-40 GHz
- 70 dB and 110 dB attenuation ranges
- Low insertion loss
- Precise repeatability
- Life of 5 million operations\*
- Small, rugged, light weight

## Advanced technology-advanced performance

Anritsu has lowered throughline loss by designing the first 40 dB attenuator sections to operate above 18 GHz. Compared with designs that use 30 dB sections, these attenuators have a shorter thru path and fewer switching contacts. As a result, insertion loss is as much as 1.7 dB less than that of units made by other companies. RF input power requirements for systems that use these attenuators can be reduced, saving money, space, and weight.

## Integrated switching structure

The push rods that switch in the attenuator modules and thru lines are driven by a solenoid actuator. By designing the solenoid as an integral part of the attenuator assembly, switching speeds of 20 ms (including settling time) are achieved after a single switch event. Upon completion of the switching operation, the solenoid is magnetically latched to withstand shock and vibration. At the same time, the solenoid current is automatically turned off to save power and to minimize temperature rise.

Also integrated in the design is solid state dc switching circuitry that avoids the relatively high failure rate of mechanical DC switches. Each attenuator section is controlled by its own driver circuit, which requires a minimum of 20 V. A typical external driver circuit for one section is shown in the figure below.

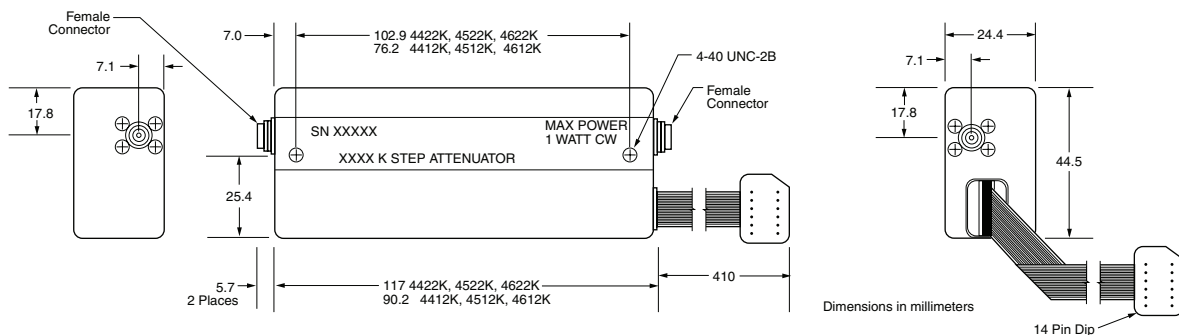
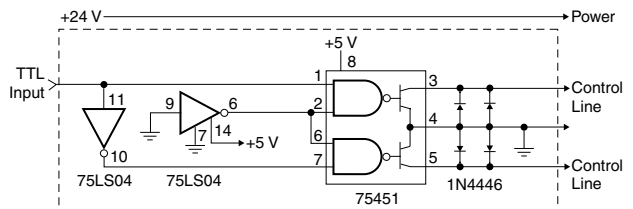

4400, 4500, and 4600 series outline

\* An operation is defined as a single switch from a particular thru to pad or pad to thru event.

# STEP ATTENUATORS

4400, 4500, 4600 Series DC to 40 GHz

## Specifications

Frequency and attenuation ranges

Model	Frequency range	Attenuation range in 10 dB steps	Connectors
4412K 4422K	DC to 20 GHz	0 to 70 dB 0 to 110 dB	K(f)
4512K 4522K	DC to 26.5 GHz	0 to 70 dB 0 to 110 dB	K(f)
4612K 4622K	DC to 40 GHz	0 to 70 dB 0 to 110 dB	K(f)

## Attenuator accuracy ( $\pm$ dB)

Frequency (GHz)	Attenuation (dB)							
	10	20	30	40	50	60	70	80-110
DC to 8	0.3	0.5	0.6	0.7	0.8	1.0	1.1	1.4
>8 to 12	0.4	0.5	0.7	0.9	1.0	1.3	1.5	2.0
>12 to 20	0.5	0.6	0.8	1.1	1.2	1.4	1.7	2.2
>20 to 26.5	0.7	0.8	1.0	1.5	1.6	1.9	2.3	2.8
>26.5 to 40	0.9	1.0	1.2	1.7	1.9	2.3	2.6	3.2

## Electrical

Switching speed (maximum)	20 ms (single switch)
Operating voltage	20 to 30 Volts
Switching control current	125 mA at 24V nominal per section 3 sections in 4412K, 4512K, 4612K 4 sections in 4422K, 4522K, 4622K
Solenoid coil impedance	$\pm 10 \Omega$
Solenoid coil inductance	65 mH
RF input power (maximum)	1W average, 100W peak for 10 $\mu$ s
RF power sensitivity	0.001 dB/W
Life (minimum operations per section)*	5 million
Repeatability (typical after 1 million operations)	$\pm 0.03$ dB to 10 GHz $\pm 0.05$ dB to 26 GHz $\pm 0.08$ dB to 40 GHz

## Insertion loss (maximum)

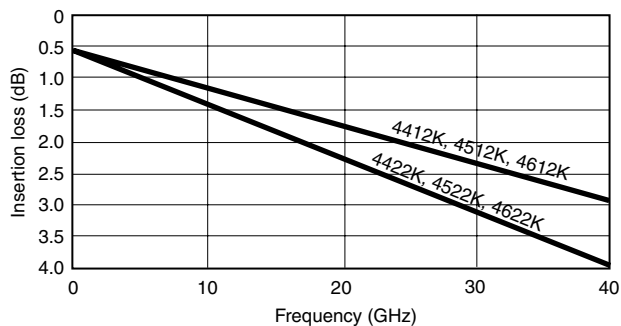

\* An operation is defined as a single switch from a particular thru to pad or pad to thru event.

## Impedance match

Frequency (GHz)	Return loss (dB)	SWR
DC to 8	19	1.25
>8 to 12	14	1.5
>12 to 20	12.7	1.6
>20 to 26.5	11	1.8
>26.5 to 40	9	2.1

## Mechanical

Weight	4412K, 4512K, 4612K: 170g 4422K, 4522K, 4622K: 213g
Mounting position	Any
RF connectors	K Connectors, female, in-line
Programming connector	14 pin DIP
Programming cable length	406 mm

## Environment

Temperature	Operating:	0C to +70C
	Non-operating:	-55C to +80C
Altitude	Operating:	4.6 km (440 mm Hg)
	Non-operating:	15 km
Shock	Operating:	10g, 6 ms, on 6 sides, 3 blows
	Non-operating:	500g, 1.8 ms, in 6 directions
Humidity	0 to 95% relative humidity	
EMC	Mil-Std-461, Method RE02, VDE 0871, CISPR#2	

## Ordering information

Please specify model/order number, name, and quantity when ordering.

Model/Order No.	Name
4412K	Step Attenuator, DC to 20 GHz, 70 dB
4512K	Step Attenuator, DC to 26.5 GHz, 70 dB
4612K	Step Attenuator, DC to 40 GHz, 70 dB
4422K	Step Attenuator, DC to 20 GHz, 110 dB
4522K	Step Attenuator, DC to 26.5 GHz, 110 dB
4622K	Step Attenuator, DC to 40 GHz, 110 dB

# AIRLINES

18, 19 Series 2 to 40 GHz



## Specifications

Model	Frequency range (GHz)	Test port connector	Beaded port connector	SWR (test port)	Dimensions L(cm) x dia(cm)
18A50	0.5 to 18	GPC-7	GPC-7	1.003	30 x 0.7
18N50	0.5 to 18	N(m)	GPC-7	1.006	30 x 0.7
19S50	0.8 to 26.5	WSMA(m)	WSMA(m)	1.006 to 18 GHz 1.010 to 26.5 GHz	25 x 0.35

Temperature range: +25°C ±5°C

## Ordering information

Please specify model/order number, name, and quantity when ordering.

Model/Order No.	Name
	Precision Air Line
18A50	0.5 to 18 GHz, 50 Ω, GPC-7
18N50	0.5 to 18 GHz, 50 Ω, N (m)
19S50	0.8 to 26.5 GHz, 50 Ω

The 18 and 19 Series Precision Airlines are the most accurate impedance standards available today, and they are the recognized traceability path for impedance at high frequencies. Anritsu airlines are a critical component when measuring accurate impedances, enabling measurements down to 1.006 SWR to 18 GHz, 1.01 SWR to 26.5 GHz, and 1.02 SWR to 40 GHz.

A beadless connector is used at the measurement end to provide a minimum reflection connection. The other end is beaded to keep the center conductor captive, thus fixing the reference plane at the beadless end.

## Features

- Plating is gold over nickel
- Provide impedance traceability to NIST
- Enable measurements down to 1.006 SWR to 18 GHz, 1.01 SWR to 26.5 GHz, and 1.02 SWR to 40 GHz

# OPEN/SHORTS

22 Series DC to 50 GHz



22K50



22KF50

The 22 Series Open/Shorts are used on the test port of an SWR Autotester or SWR bridge to establish a full reflection reference for accurate SWR measurements. When used with scalar network analyzers, the open and short reflections over a swept frequency range can be automatically averaged to enhance measurement accuracy. All models consist of an open on one end and a short on the other.

## Features

- Single Gold Plated Component providing full open and short reflections for accurate SWR measurements
- DC to 50 GHz frequency coverage
- GPC-7, Type N, K Connectors® and V Connectors®
- 50 Ω or 75 Ω impedance

## Specifications

Model	Frequency range (GHz)	Test port connector	Characteristic impedance (Ω)	Dimensions L(cm) x dia(cm)
22N75 22NF75	DC to 3	N(m) N(f)	75	6.3 x 1.8 4.9 x 1.6
22N50 22NF50	DC to 18	N(m) N(f)	50	6.3 x 1.8 4.9 x 1.6
22A50	DC to 18	GPC-7	50	3.8 x 1.6
22K50 22KF50	DC to 40	K(m) K(f)	50	4.2 x 0.8 3.5 x 0.8
22V50 22VF50	DC to 67	V(m) V(f)	50	3.6 x 0.8 2.8 x 0.8

Temperature range: +25°C ±5°C

## Ordering information

Please specify model/order number, name, and quantity when ordering.

Model/Order No.	Name
	<b>Open/Short</b>
22N50	DC to 18 GHz, N(m), 50 Ω
22NF50	DC to 18 GHz, N(f), 50 Ω
22N75	DC to 3 GHz, N(m), 75 Ω
22NF75	DC to 3 GHz, N(f), 75 Ω
22A50	DC to 18 GHz, GPC-7 connector, 50 Ω
22K50	DC to 40 GHz, K(m), 50 Ω
22KF50	DC to 40 GHz, K(f), 50 Ω
22V50	DC to 67 GHz, V(m), 50 Ω
22VF50	DC to 67 GHz, V(f), 50 Ω

# OPEN/SHORTS/LOADS

## OSL Series DC to 20 GHz Calibration Kits



The OSL series open/short/load are used on the test port of the Site Master™ Series of handheld instruments to establish a reference for accurate measurement. When used with a Site Master, the open/short and load reflection over a swept frequency range can be automatically averaged to enhance measurement accuracy. OSL series Open/short/load comes in both N(Male) and N (Female) connector configuration and consist open on one end, short on other and Load on the tee section.

### Features

- Single Component providing full open, short and load reflections for accurate measurements.
- DC to 20 GHz frequency coverage
- Type N(Male), N(Female), K(Male) and K(Female) connector configuration
- 50 Ω Impedance
- For use with:
  - All VNA Master systems
  - S412D LMR Master systems
  - MT8222A BTS Master
  - MT8212E Cell Master
  - ShockLine VNAs

### Specifications

Model	Frequency range (GHz)	Test port connector	Characteristic impedance	Open/Short Phase Shift
OSLN50A-8	DC to 8	N(m)	50	180°±10°
OSLNF50A-8	DC to 8	N(f)	50	180°±10°
OSLN50A-18	DC to 18	N(m)	50	180°±20°
OSLNF50A-18	DC to 18	N(f)	50	180°±20°
OSLK50	DC to 20	K(m)	50	180°±6°
OSLKF50	DC to 20	K(f)	50	180°±6°

Temperature range: +25°C ±5°C

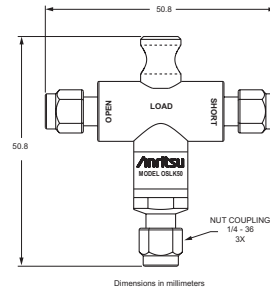

K Female Connector outline

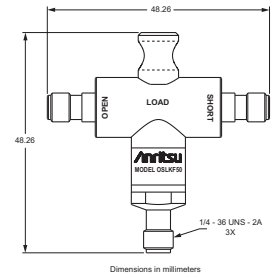

K Female Connector outline

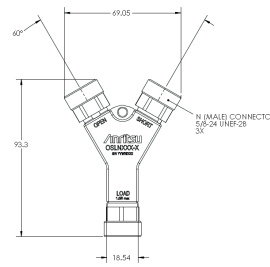

N Male Connector outline

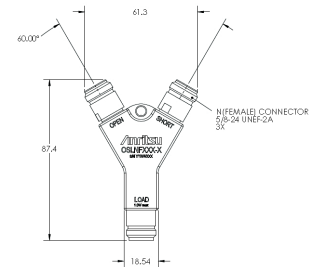

N Female Connector outline

### Ordering information

Please specify model/order number, name, and quantity when ordering.

Model/Order No.	Name
	<b>Open/Short/Load</b>
OSLN50A-8	DC to 8 GHz, N(m), 50 Ω
OSLNF50A-8	DC to 8 GHz, N(f), 50 Ω
OSLN50A-18	DC to 18 GHz, N(m), 50 Ω
OSLNF50A-18	DC to 18 GHz, N(f), 50 Ω
OSLK50	DC to 20 GHz, K(m), 50 Ω
OSLKF50	DC to 20 GHz, K(f), 50 Ω

# THRU/OPEN/SHORTS/LOADS

## TOSL Series DC to 40 GHz Calibration Kits



The TOSL series Thru/Open/Short/Load calibration kits have been designed to provide superior measurement results when used with precision instruments. It is designed for use in both field and lab environments. TOSL series Thru/Open/Short/Load comes in both N(male and female) and K(male and female) connector configurations. The K type connectors are compatible with 3.5 mm and SMA connectors.

### Features

- Single Component providing full open, short and load reflections for accurate measurements.
- Includes Thru connection
- DC to 40 GHz frequency coverage
- Type N(Male), N(Female), K(Male) and K(Female) connector configurations
- 50  $\Omega$  Impedance

### Specifications

Model	Frequency Range (GHz)	Test Port Connector	Characteristic Impedance ( $\Omega$ )	Thru Length (mm)
TOSLN50A-8	DC to 8	N(m)	50	58.5
TOSLNF50A-8	DC to 8	N(f)	50	58.5
TOSLN50A-18	DC to 18	N(m)	50	58.5
TOSLNF50A-18	DC to 18	N(f)	50	58.5
TOSLK50A-20	DC to 20	K(m)	50	16.07
TOSLKF50A-20	DC to 20	K(f)	50	16.07
TOSLK50A-40	DC to 40	K(m)	50	16.07
TOSLKF50A-40	DC to 40	K(f)	50	16.07

### Ordering information

Please specify model/order number, name, and quantity when ordering.

Model/Order No.	Name
TOSLN50A-8	High Performance with Through Type N(m) , DC to 8 GHz, 50 $\Omega$
TOSLNF50A-8	High Performance with Through Type N(f) , DC to 8 GHz, 50 $\Omega$
TOSLN50A-18	High Performance with Through Type N(m) , DC to 18 GHz, 50 $\Omega$
TOSLNF50A-18	High Performance with Through Type N(f) , DC to 18 GHz, 50 $\Omega$
TOSLK50A-20	High Performance with Through Type K(m) , DC to 20 GHz, 50 $\Omega$
TOSLKF50A-20	High Performance with Through Type K(f) , DC to 20 GHz, 50 $\Omega$
TOSLK50A-40	High Performance with Through Type K(m) , DC to 40 GHz, 50 $\Omega$
TOSLKF50A-40	High Performance with Through Type K(f) , DC to 40 GHz, 50 $\Omega$

# MICROWAVE DETECTORS

70, 75 Series 10 MHz to 50 GHz



70KA50



75N50B

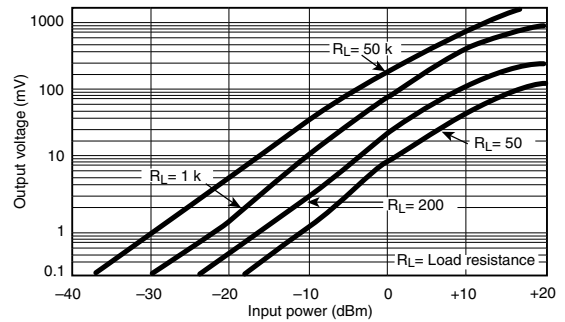

Typical sensitivity

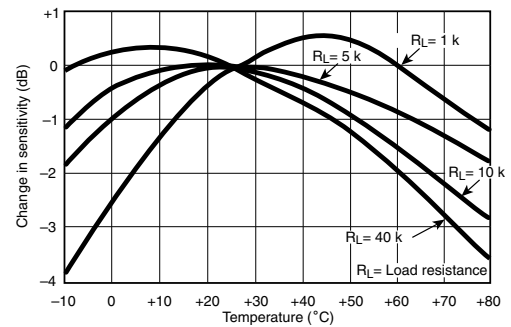

Typical sensitivity change

Within the 70 or 75 Series product lines, you will find a model that matches your needs for instrumentation, system, or OEM applications. By using the latest design and microelectronics production technologies, Anritsu low-barrier Schottky-diode detectors outperform others and offer significant cost savings. Input connector types include Type N, and K Connector® (compatible with SMA and 3.5 mm), and V Connector® (compatible with 2.4 mm). In addition to frequency coverage and price, these detectors are distinguished by their low SWR, flat frequency response, and close output-voltage tracking over a wide dynamic range.

## Features

- Broadband coverage, 10 MHz to 50 GHz with a Single Detector
- K Connector® compatible with SMA and 3.5 mm
- V Connector® compatible with 2.4 mm
- Lowest SWR: 1.33 to 20 GHz, 1.5 to 40 GHz
- Flat Response:  $\pm 0.5$  dB to 20 GHz,  $\pm 1.5$  dB to 40 GHz
- Best Value for Instrumentation, system, and OEM applications
- Low price and availability from stock
- Standard output polarity is negative
- Positive polarity is available as a special

# MICROWAVE DETECTORS

70, 75 Series 10 MHz to 50 GHz

## Specifications

Model	Frequency range	Flatness (dB)	Connectors		Impedance ( $\Omega$ )	SWR (Maximum)	Low level sensitivity at -30 dBm (mV/ $\mu$ W)	High level sensitivity at +13 dBm (Volts, Min.)	Input maximum (mW)	Output capacitance (pF)
			In	Out						
70KA50	0.01 to 20 GHz	$\pm 0.6$	K(m)	SMC(m)	50	1.33	0.6	1	100	30
70KC50	0.01 to 40 GHz	$\pm 0.5$ to 20 GHz $\pm 1.0$ to 26.5 GHz $\pm 1.5$ to 40 GHz	K(m)	SMC(m)	50	1.33 to 20 GHz 1.50 to 26.5 GHz 1.90 to 40 GHz	0.4	1	100	30
75N50B	0.01 to 18.5 GHz	$\pm 0.3$ to 12.4 GHz $\pm 0.6$ to 18.5 GHz	N(m)	BNC(f)	50	1.15 to 4.5 GHz 1.30 to 15 GHz 1.39 to 18.5 GHz	0.35	1	100	30
75KC50	0.01 to 40 GHz	$\pm 0.5$ to 20 GHz $\pm 1.0$ to 26.5 GHz $\pm 1.5$ to 40 GHz	K(m)	BNC(f)	50	1.33 to 20 GHz 1.50 to 26.5 GHz 1.90 to 40 GHz	0.4	1	100	30
75VA50	0.01 to 50 GHz	$\pm 0.5$ to 20 GHz $\pm 1.0$ to 26.5 GHz $\pm 1.5$ to 40 GHz $\pm 3$ to 50 GHz	V(m)	BNC(f)	50	1.33 to 20 GHz 1.50 to 26.5 GHz 1.90 to 40 GHz 2.1 to 50 GHz	0.4	1	100	30

## Dimensions

Model	Dimensions L(cm) x dia(cm)
70KA50	4.6 x 1.0
70KC50	4.6 x 1.0
75N50B	6.4 x 1.8
75KC50	4.6 x 1.0
75VA50	4.6 x 1.0

## Ordering information

Please specify model/order number, name, and quantity when ordering.

Model/Order No.	Name
	<b>Microwave Detector</b>
70KA50	10 MHz to 20 GHz, K(m) input, SMC(m) output, 50 $\Omega$
70KC50	10 MHz to 40 GHz, K(m) input, SMC(m) output, 50 $\Omega$
75KC50	10 MHz to 40 GHz, K(m) input, BNC(f) output, 50 $\Omega$
75N50B	10 MHz to 18.5 GHz, N(m) input, BNC(f) output, 50 $\Omega$
75VA50	10 MHz to 50 GHz, V(m) input, BNC(f) output, 50 $\Omega$

\* Upper frequency limit (GHz):  $\leq 8$ ,  $\leq 12.4$ ,  $\leq 18$ ,  $\leq 26.5$ ,  $\leq 40$

\*\* Frequency response tracking (dB):  $\pm 0.2$ ,  $\pm 0.3$ ,  $\pm 0.6$ ,  $\pm 0.8$ ,  $\pm 1.2$



# POWER DIVIDERS

11 Series DC to 3000 MHz

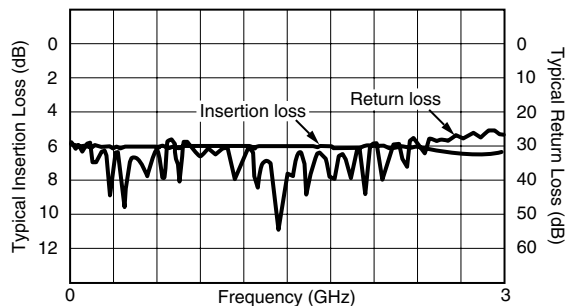

Insertion loss (typical) /return loss (typical)

These RF power dividers are symmetrical, three-resistor tee designs that can be used in applications where signals from DC to 3000 MHz must be accurately divided. They are available in 50 Ω and provide excellent amplitude and phase tracking.

## Features

- DC to 3000 MHz frequency range
- Excellent amplitude and phase tracking
- 50 Ω characteristic impedance

## Specifications

Model	Frequency range (MHz)	SWR	Insertion loss (dB, max.)	Impedance (Ω)	Connectors	
					Input	Output
11N50B	DC to 3000	<1.25	7	50	N(f)	N(f)

**Maximum Input Power:** 1 Watt  
**Temperature range:** 0°C to +70°C

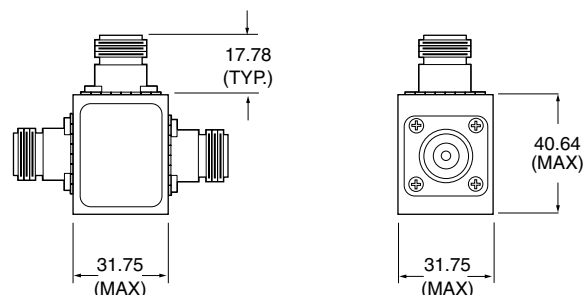

Dimensions in millimeters

11N50B outline

## Ordering information

Please specify model/order number, name, and quantity when ordering.

Model/Order No.	Name
11N50B	Power Divider, 1 MHz to 3 GHz, 50 Ω

# POWER DIVIDERS

K240, V240 Series DC to 65 GHz

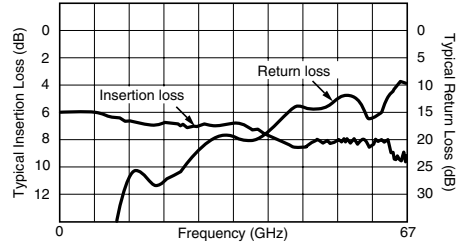
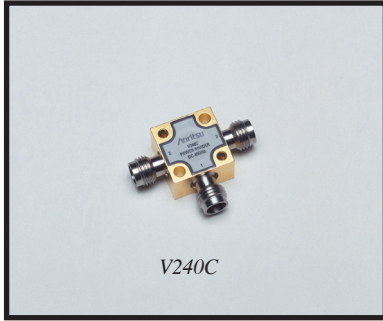

Insertion loss (typical) /return loss (typical) for V240C

These microwave power dividers are symmetrical, three-resistor tee designs that can be used in applications where signals from DC to 65 GHz must be accurately divided or combined. K Connector® is compatible with 3.5 mm and SMA; V Connector® is compatible with 2.4 mm. All models have exceptional amplitude and phase tracking characteristics.

## Features

- DC to 65 GHz frequency range
- K Connector® compatibility with SMA/3.5 mm
- V Connector® compatibility with 2.4 mm
- Excellent amplitude and phase tracking

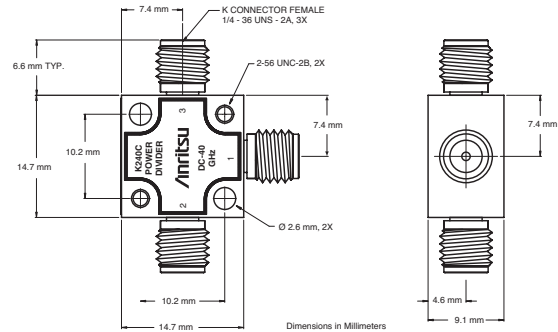

K240B, K240C outline

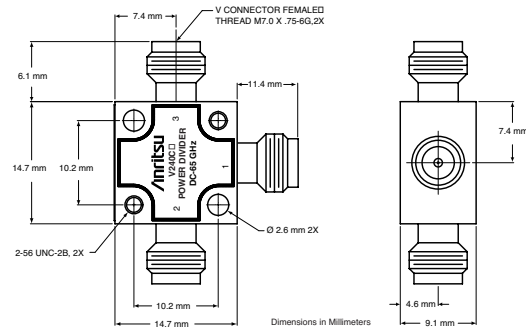

V240C outline

## Specifications

Model	Frequency range (GHz)	Impedance ( $\Omega$ )	Connectors
K240B	DC to 26.5	50	K(f)
K240C	DC to 40	50	K(f)
V240C	DC to 65	50	V(f)

Frequency range (GHz)	Tracking of outputs		Insertion loss (dB max.)	SWR
	Amplitude	Phase		
DC to 6	$\pm 0.3$ dB	$\pm 2^\circ$	7	1.22
6 to 18	$\pm 0.3$ dB	$\pm 3^\circ$	7.5	1.44
18 to 26.5	$\pm 0.6$ dB	$\pm 4^\circ$	8	1.58
26.5 to 40	$\pm 0.6$ dB	$\pm 6^\circ$	8.5	1.79
40 to 65	$\pm 1.8$ dB	$\pm 18^\circ$	10	3.11

Maximum Input Power: 1W  
 Temperature range: 0°C to +70°C  
 Weight: 43g

## Ordering information

Please specify model/order number, name, and quantity when ordering.

Model/Order No.	Name
K240B	Precision Power Divider, DC to 26.5 GHz
K240C	Precision Power Divider, DC to 40 GHz
V240C	Precision Power Divider, DC to 65 GHz

# POWER SPLITTERS

K241, V241 Series, DC to 65 GHz

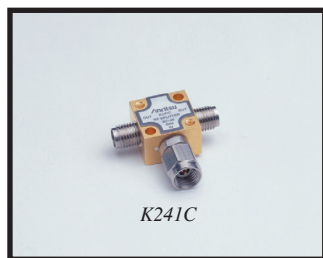

K241C



V241C

These microwave power splitters are symmetrical, two-resistor designs that can be used in applications where signals from DC to 65 GHz must be accurately divided for ratio measurements. They provide excellent flatness and effective output SWR. K Connectors® are compatible with 3.5 mm and SMA; V Connectors® are compatible with 2.4 mm.

## Features

- DC to 65 GHz frequency range
- K Connector® compatibility with SMA/3.5 mm
- V Connector® compatibility with 2.4 mm
- Excellent flatness and effective output SWR

## Specifications

Model	Frequency range (GHz)	Impedance (Ω)	Connectors	
			Input	Output
K241B	DC to 26.5	50	K(m)	K(f)
K241C	DC to 40	50	K(m)	K(f)
V241C	DC to 65	50	V(m)	V(f)

Model	Frequency range (GHz)	Flatness (dB)	Input SWR	Effective output SWR	Insertion loss (dB)
K241B	DC to 26.5	2.0	1.45	1.45	7.5
K241C	DC to 26.5	2.0	1.45	1.45	7.5
	26.5 to 40	2.0	1.93	1.70	8.5
V241C	DC to 18	2.0	2.11	2.00	8.5
	18 to 40	2.0	2.33	2.30	9.5
	40 to 65	2.0	2.62	2.60	10.5

**Maximum Input Power:** 1W  
**Temperature range:** 0°C to +70°C  
**Weight:** 43g

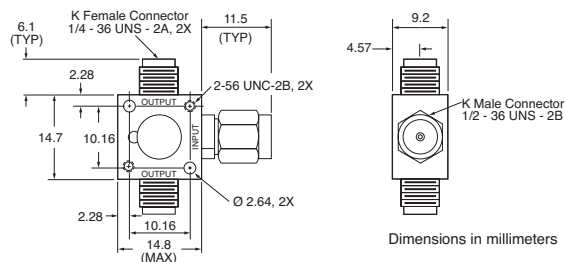

K241B, K241C outline

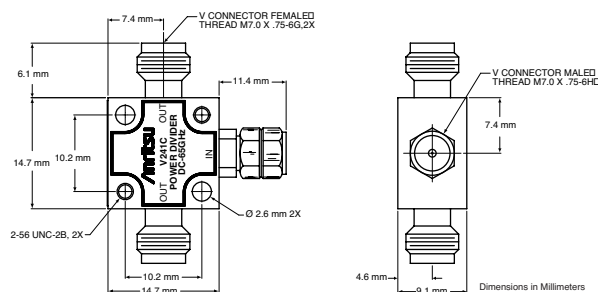

V241C outline

## Ordering information

Please specify model/order number, name, and quantity when ordering.

Model/Order No.	Name
K241B	Precision Power Splitter, DC to 26.5 GHz
K241C	Precision Power Splitter, DC to 40 GHz
V241C	Precision Power Splitter, DC to 65 GHz

# POWER SPLITTERS

N241 Series, DC to 3000 MHz

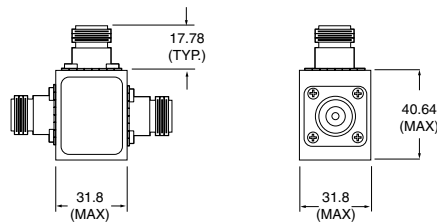

Dimensions in millimeters

N241A50 outline

These RF power splitters are symmetrical, two resistor designs that can be used in applications where signals from DC to 3000 MHz must be accurately divided for ratio measurements. They are available in 50 Ω and provide excellent flatness and effective output SWR.

## Features

- DC to 3000 MHz frequency range
- Excellent flatness and effective output SWR
- 50 Ω Impedance

## Specifications

Model	Frequency range	Input SWR	Effective output SWR	Insertion loss	Flatness	Impedance	Connectors
N241A50	DC to 3000 MHz	1.3	1.3	7.5 dB	±1.5 dB	50 Ω	Input: N(f) Output: N(f)

**Maximum Input Power:** 1/2 W  
**Temperature range:** 0°C to +70°C

## Ordering information

Please specify model/order number, name, and quantity when ordering.

Model/Order No.	Name
N241A50	Power Splitter, DC to 3000 MHz, 50 Ω

# BIAS TEE

K250 100 MHz to 40 GHz, V250 100 MHz to 60 GHz



## Specifications

Temperature	0 to 60°C
Mounting position	Any
Weight	57g

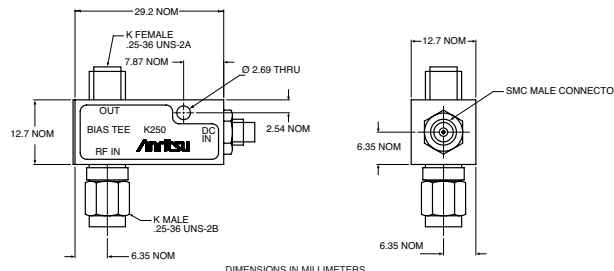

Outline (K and V models)

These bias tees are designed for applications where both DC and RF signals must be applied to a device under test. They are particularly suited for active device measurements. DC voltages of up to 30 volts at 0.5 amps may be applied to test devices with negligible effect on RF performance. Low RF throughline loss (<1 dB) and low return loss ensure negligible effect on measurements up to 60 GHz. An RF input DC block isolates the input port from the applied bias voltage.

## Features

- Broadband, 0.1 to 60 GHz coverage
- Low SWR, low insertion loss
- K Connector® and V Connector® availability

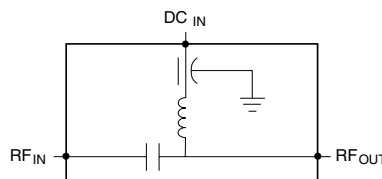

Schematic diagram (K and V models)

## Specifications

Model	Frequency range	Insertion loss	Return loss	RF power	DC voltage	DC current	DC port isolation	RF connectors	DC connectors
K250	0.1 to 40 GHz <sup>①</sup>	1.2 dB typ.	15 dB min. to 20 GHz 10 dB min. to 40 GHz	1W max.	30V max.	0.5A	20 dB at 0.1 GHz 40 dB above 0.5 GHz	Input: K(m) Output: K(f)	SMC(m)
V250	0.1 to 60 GHz <sup>①</sup>	2.2 dB typ.	13 dB min. to 20 GHz 9 dB min. to 40 GHz 8 dB min. to 60 GHz	1W max.	30V max.	0.5A	20 dB at 0.1 GHz 40 dB above 0.5 GHz	Input: V(m) Output: V(f)	SMC(m)

<sup>①</sup> Usable between 0.04 and 0.1 GHz with degraded performance.

Temperature range: 0°C to +70°C

## Ordering information

Please specify model/order number, name, and quantity when ordering.

Model/Order No.	Name
K250	Precision Bias Tee, 100 MHz to 40 GHz
V250	Precision Bias Tee, 100 MHz to 60 GHz

# ULTRA-WIDEBAND BIAS TEES

K251 50 kHz to 40 GHz, V251 100 kHz to 65 GHz

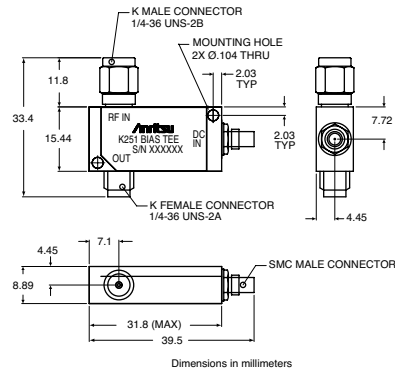
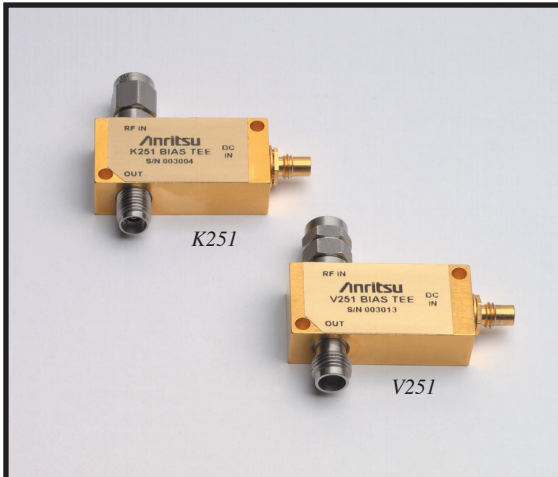

K251 outline

These ultra-wide bandwidth bias tees have been optimized for optical communications and other high-speed pulse, data or microwave applications. Designed to simultaneously apply both DC and RF drive signals to a device via a single input port, these bias tees feature fast rise times, excellent low frequency response, minimum insertion loss and flat group delay. Precision K Connector® and V Connector® interfaces assure excellent impedance match across the wide bandwidths available. A one year warranty is provided. Adapters are available to convert between K and V Connectors - See page 21 of this catalog for details.

## Features

- Ideal for Optical Communications Applications
- Low Insertion Loss
- Risetime: <5 ps typical (V251), <7 ps typical (K251)

## Specifications

Model	Frequency range 3dB BW	Insertion loss	Return loss	Rise time	Group delay	Max DC current	Max DC voltage	Max RF power	Connectors
K251	50 kHz to 40 GHz	<2 dB typical	See Plot	< 7 ps typical	110 ± 2 ps typical	100 mA	16VDC	1 W	RF In: K(m) RF Out: K(f) Bias: SMC(m)
V251	100 kHz to 65 GHz	< 2.5 dB typical	See Plot	< 5 ps typical	113 ± 2 ps typical	100 mA	16VDC	1 W	RF In: V(m) RF Out: V(f) Bias: SMC(m)

Specifications apply over the full DC Bias current range and over the temperature range of 0°C to +70°C.

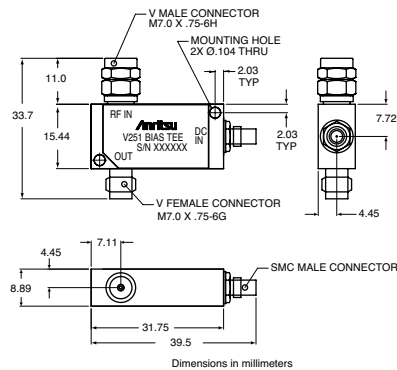

V251 outline

# ULTRA-WIDEBAND BIAS TEES

K251 50 kHz to 40 GHz, V251 100 kHz to 65 GHz

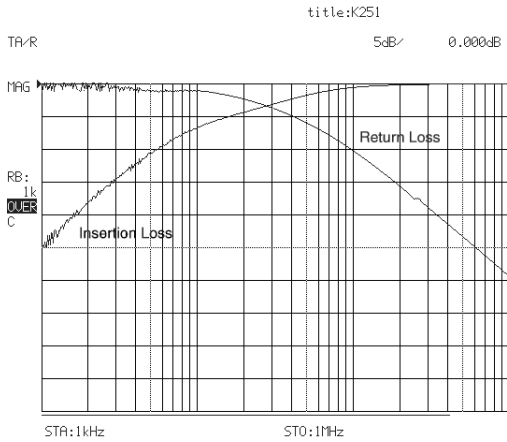

Typical Low Frequency Insertion Loss and Return Loss measured on K251 over the range of 1kHz to 1 MHz.

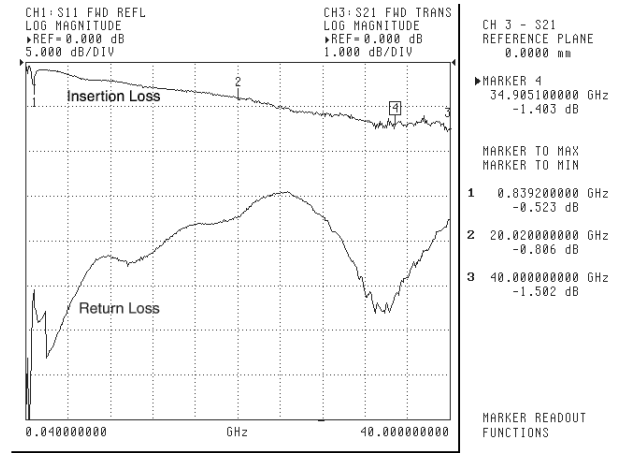

Typical Frequency Insertion Loss and Return Loss measured on K251 over the range of 40 MHz to 40 GHz.

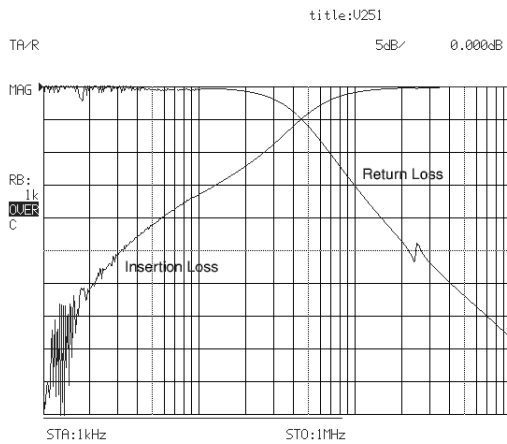

Typical Low Frequency Insertion Loss measured on V251 over the range of 1 kHz to 1 MHz.

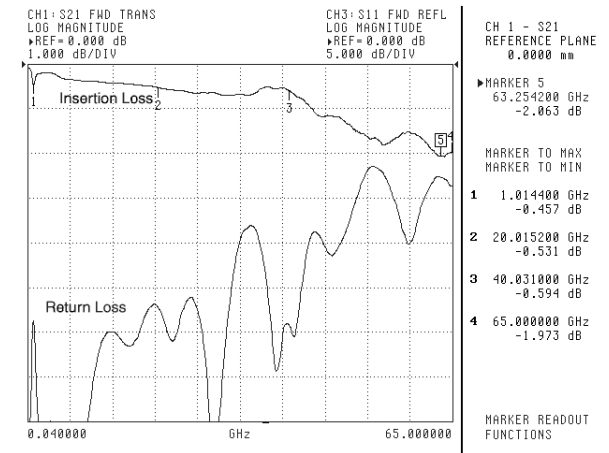

Insertion Loss and Return Loss measured on V251 over the range of 40 MHz to 65 GHz.

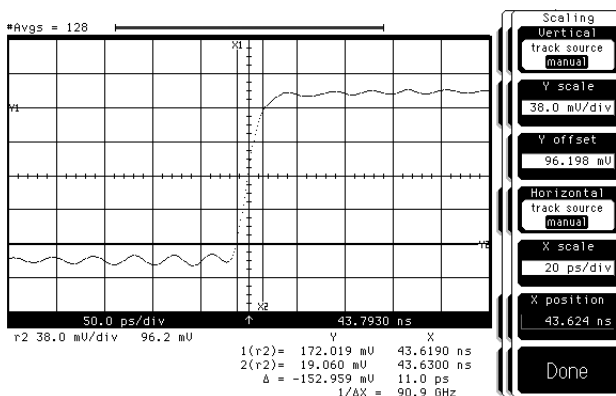

Typical Uncorrected Pulse Response for V251. Absolute risetime for the Bias Tee is derived from this measured data by applying the RSS method to compensate for the risetime of the input pulse.

$$\sqrt{T_{BT}^2 + T_{PG}^2} = T_{meas.}$$

$T_{meas.}$  = uncorrected risetime  
 $T_{BT}$  = absolute Bias Tee risetime  
 $T_{PG}$  = risetime of input pulse

## Ordering information

Please specify model/order number, name, and quantity when ordering.

Model/Order No.	Name
K251	Precision Bias Tee, 50 kHz to 40 GHz
V251	Precision Bias Tee, 100 kHz to 65 GHz

# ULTRA-WIDEBAND BIAS TEES

V255 50 kHz to 65 GHz

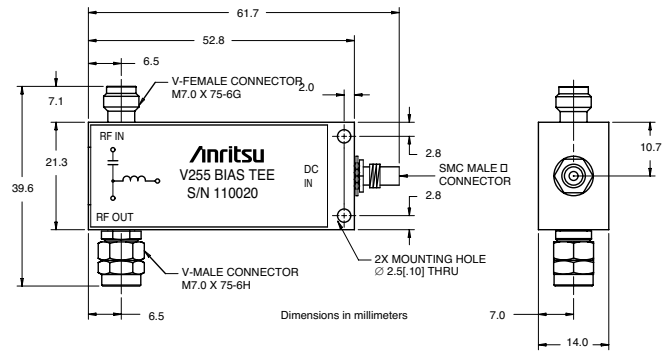
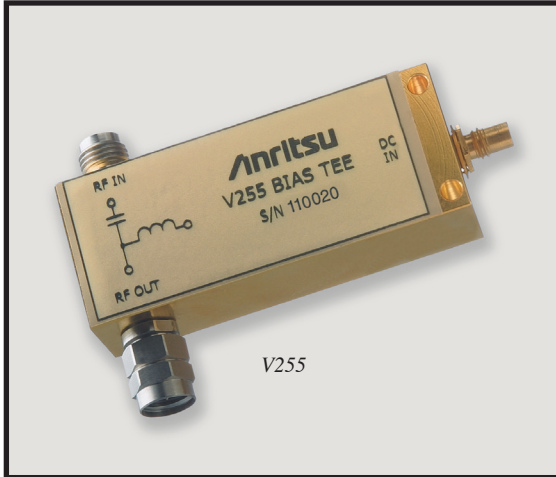

V255 outline

The V255 Gen II Ultra Wideband Bias Tee is designed to meet the high electrical performance requirement of passive components in optical communication networks. Given a broader bandwidth of 50 kHz to 65 GHz, with low insertion losses and very good return loss, makes it ideal to use in 40 Gbps systems to bias optical modulators and broad band data drivers. Its fast rise time and flat group delay performance allows extremely accurate measurements within a laboratory environment. The V255 Bias Tee comes with a standard V Connector® that assures excellent impedance match across the available wide bandwidth. The DC signal can be applied or extracted from the bias tee through an SMC connector at the third port. As with our other bias tees, the V255 also has a one-year warranty.

## Features

- Ideal for Optical Communication applications.
- Very low Insertion Loss
- Rise Time 3 ps typical
- High Current Capacity
- High Isolation between Input Port and DC Port

## Specifications

Model	Frequency range	Insertion loss	Return loss	Rise time	Group delay	Max DC current	Max DC voltage	Min. Isolation	Operating temperature
V255	50 kHz to 65 GHz (30 kHz to 65 GHz typical)	1.2 dB to 65 GHz typical	<-15 dB to 65 GHz typical	3 ps typical	125 ± 2 ps typical	400 mA	16 VDC	-50 dB	0°C to 80°C



# ULTRA-WIDEBAND BIAS TEES

V255 50 kHz to 65 GHz

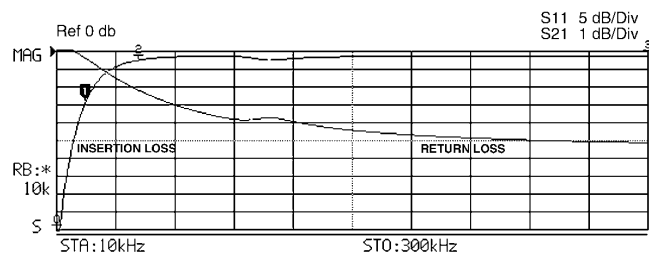
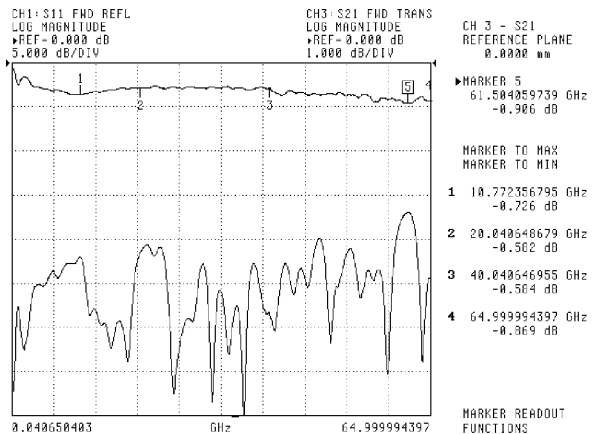

Typical Low Frequency Insertion Loss and Return Loss measured on V255 Bias Tee over the range of 10 kHz to 300 kHz

Typical High Frequency Insertion Loss and Return Loss measured on V255 over the range of 40 MHz to 65 GHz using Anritsu 37397C VNA

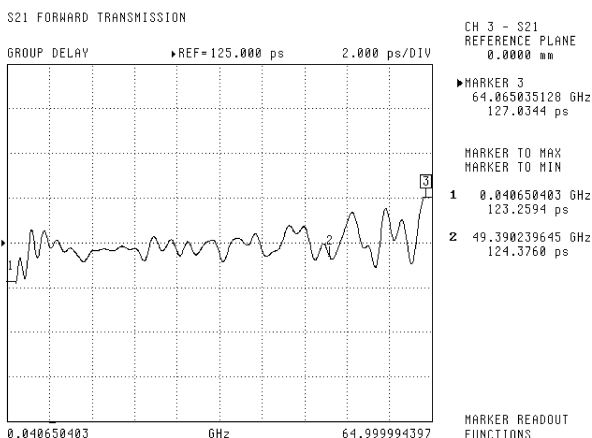

Typical Group Delay Performance measured on V255 using Anritsu 37397C VNA

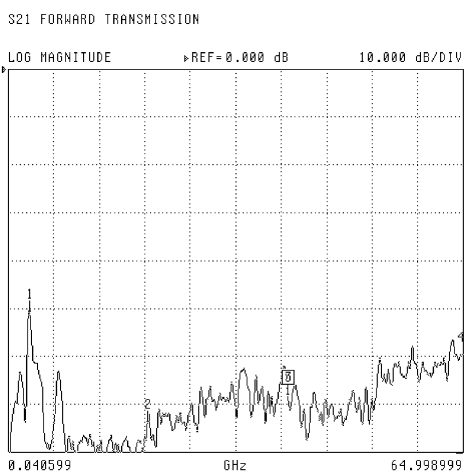

Typical Isolation between Data I/P and DC Port using Anritsu 37397C VNA

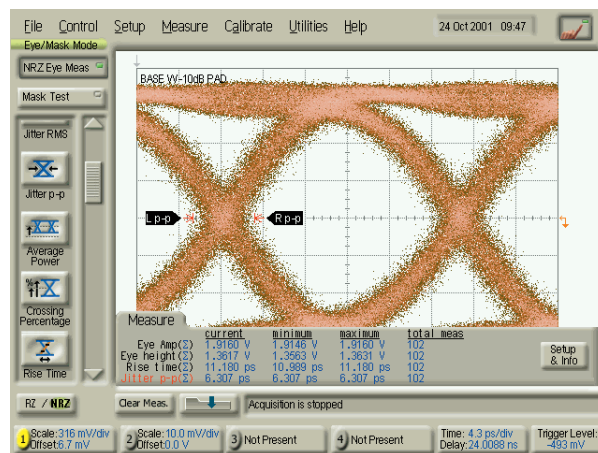

Input Test Signal to V255 2.0 V NRZ Input Signal using Anritsu 43G ME7750A BERT

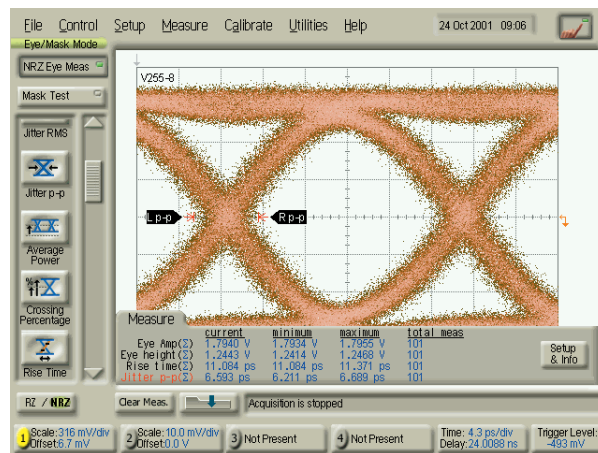

V255 Output Response to 2.0V NRZ Input Signal using Anritsu 43G ME7750A BERT

## Ordering information

Please specify model/order number, name, and quantity when ordering.

Model/Order No.	Name
V255	Gen II Wideband Bias Tee, 50 kHz to 65 GHz

# KELVIN CONNECTION BIAS TEE

K252, V252 DC to 65 GHz

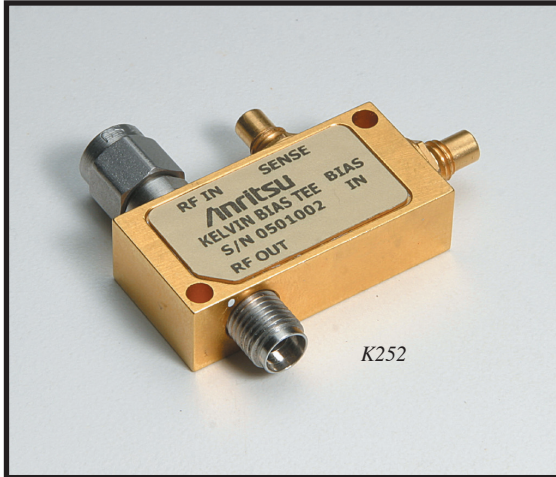

Kelvin Connection Bias Tee is designed for applications where both DC and RF signals are applied to the Device under Test (DUT) and precision DC measurements are required. A high resistance of the DC Coil results in a voltage drop that leads to a DC Biasing voltage error in the measurements. A Kelvin connection bias tee is used to eliminate DC Biasing errors as the sense coil allows accurate measurement of the DC Voltage applied across the DUT. Both 40 GHz and 65 GHz models are available with precision K connectors® and V Connectors® respectively. A male connector for the RF input and a female connector for the output is the standard interface for K252 and V252 Bias Tees. A SMC connector is standard for DC Bias and Sense connections. Other connector types with different connector configurations can be ordered through factory.

## Features

- Broadband 0.1 to 65 GHz frequency coverage
- 50 V and 500 mA Current capability
- Low Insertion and SWR performance

Model	Frequency Range 3dB BW	Insertion Loss	Return Loss	Max DC Current	Max DC Voltage	Max RF Power	Connectors	Inductance
K252	100 MHz to 40 GHz	<2.5 dB typical	11 dB	500 mA	50 VDC	1 W	RF In: K(m) RF Out: K(f) Bias: SMC(m) Sense: SMC(m)	Bias: 14 $\mu$ H Sense: 8 $\mu$ H
V252	100 MHz to 65 GHz	<3.7 dB typical	10 dB to 60 GHz 8 dB to 65 GHz	500 mA	50 VDC	1 W	RF In: V(m) RF Out: V(f) Bias: SMC(m) Sense: SMC(m)	Bias: 14 $\mu$ H Sense: 8 $\mu$ H

## Ordering information

Please specify model/order number, name, and quantity when ordering.

Model/Order No.	Name
K252	Kelvin Bias Tee, 0.1 to 40 GHz
V252	Kelvin Bias Tee, 0.1 to 65 GHz

# PRECISION DC BLOCKS

K261, 10 kHz to 40 GHz, V261 50 kHz to 65 GHz

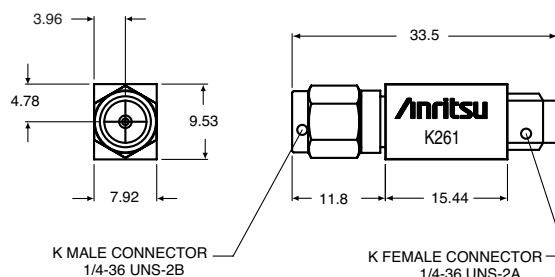
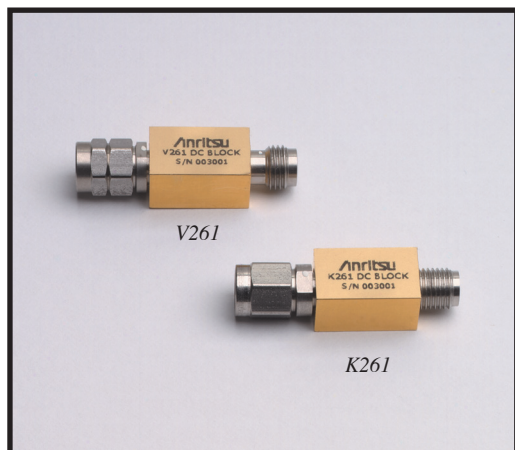

Dimensions in millimeters

K261 outline

These ultra-wide bandwidth DC Blocks have been optimized for optical communications and other high-speed pulse, data or microwave applications. Designed to apply AC drive signals to a device while eliminating any DC components, these DC Blocks feature wide bandwidth, excellent low frequency response, minimum insertion loss and flat group delay. Precision K Connector® and V Connector® interfaces assure excellent impedance match across the wide bandwidths available. A one year warranty is provided.

## Features

- Ideal for Optical Communications and high speed Pulse Applications
- <1.0 dB Insertion Loss (K261)
- Risetime: <5 ps (V261), <7 ps (K261)

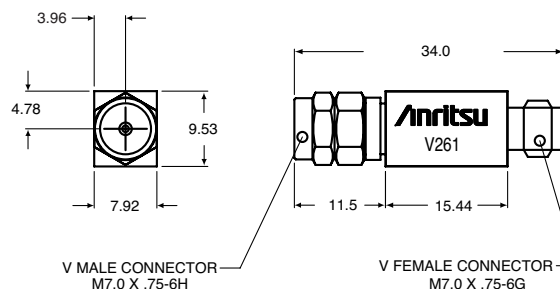

Dimensions in millimeters

V261 outline

## Specifications

Model	Frequency range 3 dB BW	Insertion loss	Return loss	Rise time	Group delay	Max DC voltage	Max RF power	Connectors
K261	10 kHz to 40 GHz	<1.0 dB typical	See Plot	< 7 ps typical	110 ±1 ps typical	16VDC	1 W	RF In: K(m) RF Out: K(f)
V261	50 kHz to 65 GHz	< 2.0 dB typical	See Plot	< 5 ps typical	113 ±1 ps typical	16VDC	1 W	RF In: V(m) RF Out: V(f)

Specifications apply over the temperature range of 0°C to +70°C.

# PRECISION DC BLOCKS

K261, 10 kHz to 40 GHz, V261 50 kHz to 65 GHz

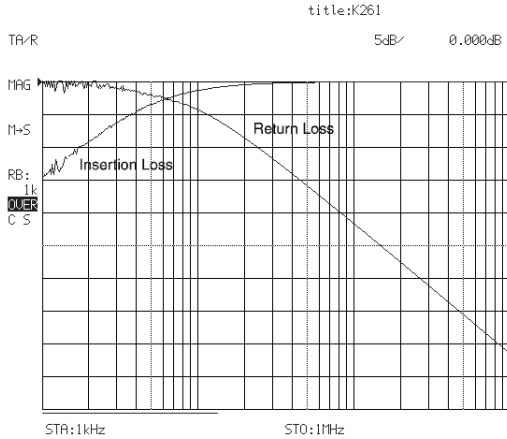

Typical Low Frequency Insertion Loss measured on K261 over the range of 1 kHz to 1 MHz.

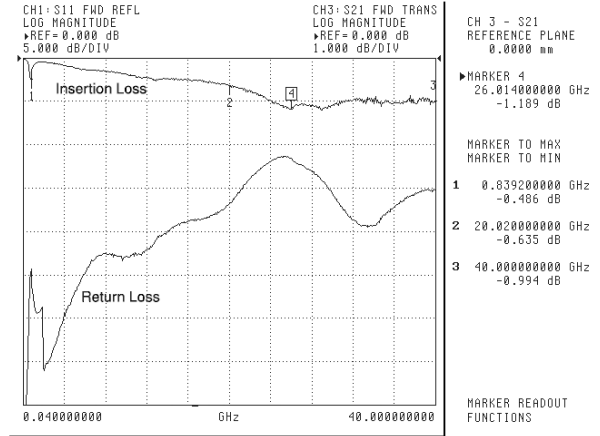

Insertion Loss and Return Loss measured on K261 over the range of 40 MHz to 40 GHz.

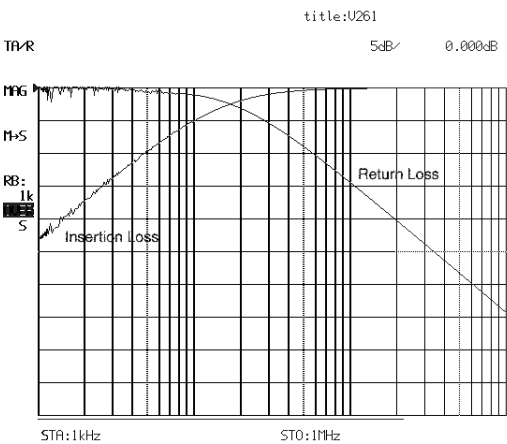

Typical Low Frequency Insertion Loss measured on V261 over the range of 1 kHz to 1 MHz.

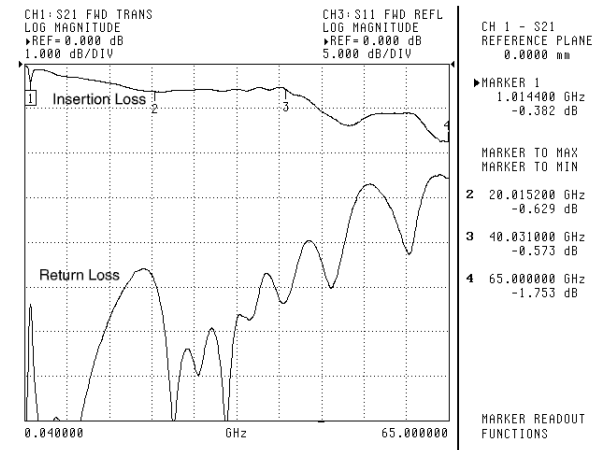

Insertion Loss and Return Loss measured on V261 over the range of 40 MHz to 65 GHz.

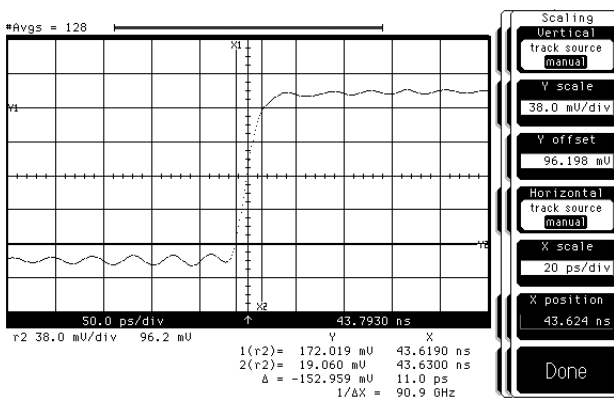

Typical Uncorrected Pulse Response for V261. Absolute risetime for the DC Blocks is derived from this measured data by applying the RSS method to compensate for the risetime of the input pulse.

$$\sqrt{T_{BT}^2 + T_{PG}^2} = T_{meas}$$

$T_{meas}$  = uncorrected risetime  
 $T_{BT}$  = absolute Bias Tee risetime  
 $T_{PG}$  = risetime of input pulse

## Ordering information

Please specify model/order number, name, and quantity when ordering.

Model/Order No.	Name
K261	Precision DC Block, 10 kHz to 40 GHz
V261	Precision DC Block, 50 kHz to 65 GHz

# DC BLOCKS

V265, 50 kHz to 65 GHz

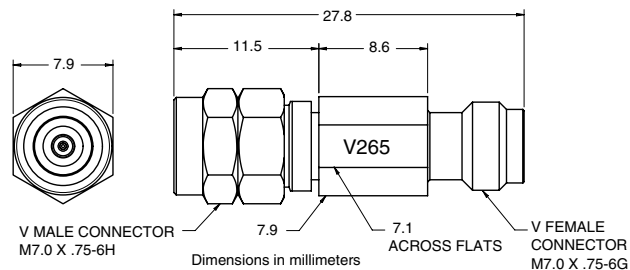

V265 outline

The V265 DC Block has been designed and optimized for optical communications and other high speed pulse, data or microwave applications. Based on the coaxial resilient connection – which is the same as on our V255 Gen II Bias Tee – it provides excellent low frequency response with very low losses and flat group delay over the temperature of operation. Designed to apply AC drive signals to a device while eliminating any DC voltage or current components, the V265 DC Block can be used in isolating DC leakage between two electrical components. The DC block comes with a standard V Connector® and assures excellent impedance match across the wide bandwidth available. A one-year warranty is provided.

## Features

- *Ideal for Optical Communication applications.*
- *Low Insertion Loss*
- *Rise Time 3 ps typical*

## Specifications

Model	Frequency range	Insertion loss	Return loss	Rise time	Group delay	Max DC voltage	Max RF power	Connectors	Operating temperature
V265	50 kHz to 65 GHz 30 kHz to 65 GHz typical	<0.7 dB to 65 GHz typical	-15 dB to 65 GHz typical	3 ps typical	84 ±2 ps typical	16 VDC	1 W	RF In: V(f) RF Out: V(m)	0°C to 80°C

# DC BLOCKS

V265, 50 kHz to 65 GHz

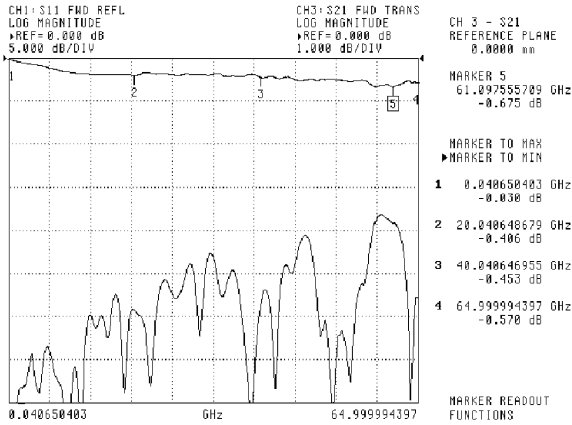

Typical High Frequency Insertion Loss and Return Loss measured on V265 over the range of 40 MHz to 65 GHz using Anritsu 37397C VNA

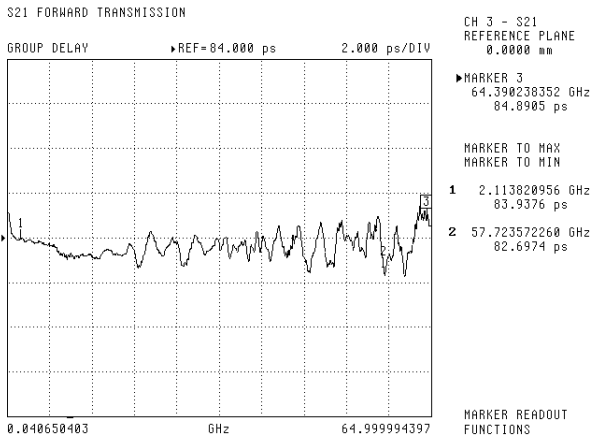

Typical Group Delay Performance measured on V265 using Anritsu 37397C VNA

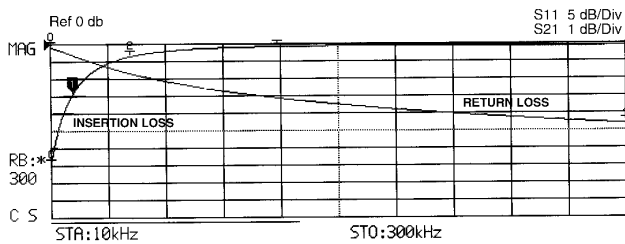

Typical Low Frequency Insertion Loss and Return Loss measured on V265 Bias Tee over the range of 10 kHz to 300 kHz using Anritsu MS4630B Network Analyzer

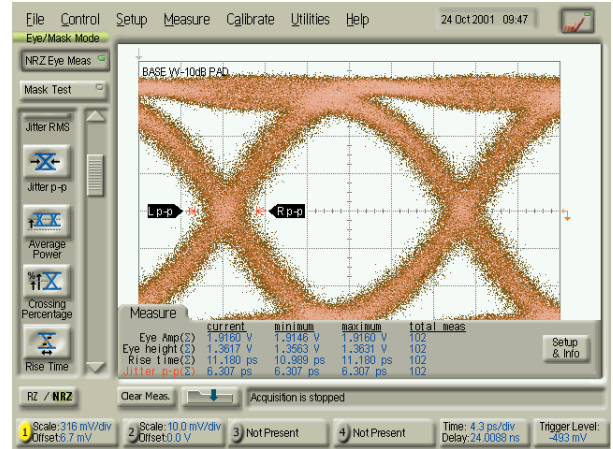

Input Test Signal to V265 2.0 V NRZ Input Signal using Anritsu 43G ME7750A BERT

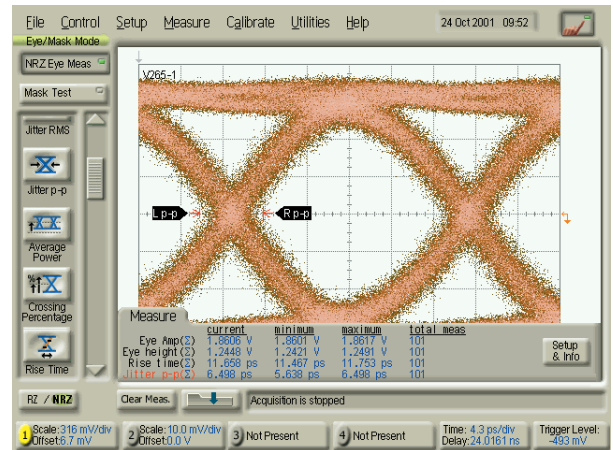

V265 Output Response to 2.0V NRZ Input Signal using Anritsu 43G ME7750A BERT

## Ordering information

Please specify model/order number, name, and quantity when ordering.

Model/Order No.	Name
V265	DC Block, 50 kHz to 65 GHz

# UNIVERSAL TEST FIXTURES

3680 Series DC to 60 GHz



The 3680 series provide an accurate, repeatable solution for measuring microstrip and Coplanar substrate devices. Input and output connections are made to the substrate device by two spring-loaded jaws that include coax-to-microstrip/Coplanar launchers. The jaws accommodate substrates from 0.13 to 1.9 mm in thickness. No center section is required. One jaw is movable in two dimensions to accommodate substrates up to 50 mm long (100 mm for 3680-20) and substrates with line offsets of up to 12.7 mm (25 mm for 3680-20). The 3680 series includes three models: the 3680-20 covers DC to 20 GHz with APC-3.5™ connectors, the 3680K covers DC to 40 GHz with Anritsu's K Connector®, and the 3680V covers DC to 60 GHz with Anritsu's V Connector®.

## Features

- DC to 60 GHz coverage
- Microstrip and coplanar measurement capability
- Accommodates offset and right-angle test devices
- Calibration/verification kits (optional)
- Substrate measurement capability

## Substrate Measurement Capability

Providing substrate measurement capability for your microstrip or coplanar waveguide designs, the 3680 Series Universal Test Fixtures allow accurate, repeatable transitions from coax to microstrip or coax to coplanar waveguide (CPW). Complete substrate measurement systems comprised of a Universal Test Fixture, a vector or scalar network analyzer, and a "substrate" Calibration Kit can fulfill your microstrip or CPW test needs. Anritsu provides the complete measurement solution, the test fixtures, the calibration kits, and the test equipment for measurements on substrate devices. Our total system responsibility ensures compatible system components, designed to work together properly. Guaranteed system specs provide assurance that your test results are accurate and verifiable.

## Universal Test Fixtures

The most critical part of any substrate measurement system is the launching fixture. It must be simple yet flexible, easy to use, and most of all provide accurate, repeatable measurements. Our Universal Test Fixtures are designed to meet these requirements. Three versions of the Universal Test Fixture are available: the 3680-20, DC to 20 GHz; the 3680K, DC to 40 GHz; and the 3680V, DC to 60 GHz. The fixture consists of a fixed connector and a movable connector that can be positioned for substrates up to 2 inches long. No center section is required. The substrate is held in place between springloaded jaws. This allows the fixture to accommodate different devices without requiring a custom center section for each different length. The unique jaw action ensures solid, repeatable electrical contact. The jaw tension is defined by the force of a spring, independent of human judgment errors. This means the tension will always be the same, providing more repeatable measurements. Dielectric rods behind the jaws accurately position the substrate away from the

launch to reduce fringing capacitance and contribute to the fixture's excellent repeatability. With a Universal Test Fixture you can be sure your measurements are both accurate and repeatable.

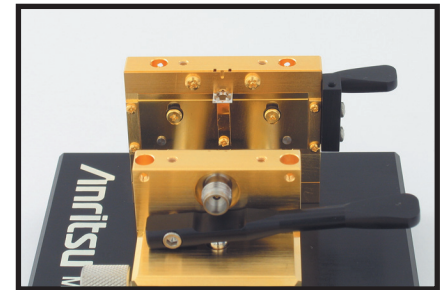

## Microstrip or Coplanar Waveguide Measurements

The unique design of the 3680 provides measurement capability for either microstrip or coplanar waveguide (CPW) designs. All that is required is a simple jaw change. The 3680 does the job of two fixtures, saving you time and money. A substrate measurement system with both the

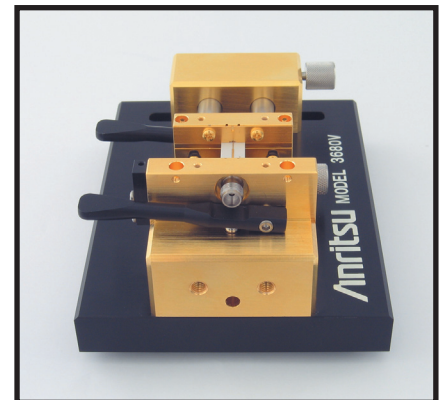

VectorStar and ShockLine VNA is the only measurement system capable of directly providing microstrip dispersion compensation. Microstrip is a dispersive media - phase shift is not linear with respect to frequency. Our Vector Network Analyzer's ability to compensate for this dispersion can dramatically improve vector measurement accuracy and provide you with the most accurate vector measurements possible.

# UNIVERSAL TEST FIXTURES

3680 Series DC to 60 GHz

## Offset Measurements

With a 3680-based substrate measurement system, there is no need to force your designs into a straight line or leave your designs untested. The 3680 has the ability to offset lines by as much as  $\pm 1.0$  inch.

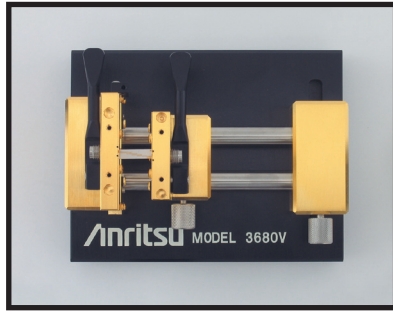

Many designs, such as filters, require parallel traces that are offset. In the past, designers were forced to add extra line lengths, create one-of-a-kind custom fixtures, or worse, not test offset designs. With the flexibility of the 3680, you can test offset or in-line designs with one setup. Formerly-untestable designs can now be tested with ease.

## Right-Angle Measurements

Testing designs with right-angle connections is made easy. The optional right-angle launcher adds a connection at  $90^\circ$  to the fixture. This lets you test devices with right-angle connections with precision and repeatability corresponding to an in-line measurement. The fixture is designed to fit your device; you don't have to design your device to fit the fixture. The right-angle launcher also provides another benefit - the ability to test multiport devices. With the addition of right-angle launchers, the 3680 can become a three port, or even four port launching fixture. A VectorStar VNA-based microstrip measurement system with optional dual source control can interdependently control up to two sources and a receiver, for testing mixers or other frequency conversion devices. Now a microstrip or CPW mixer, converter, or other device can be tested, with the same convenience as a packaged device.

## 60 GHz Measurements

Anritsu was the first manufacturer to offer a coaxial VNA with continuous 0.04 GHz to 60 GHz measurement capability. With the 3680 Series Universal Test Fixtures, that measurement capability is extended onto the substrate. An Anritsu VNA-based substrate measurement system is capable of measurements from 0.04 GHz to 60 GHz in one setup. And the optional 60 GHz time domain capability provides time or distance measurements with unsurpassed resolution. Discontinuities as close as 1.2 mm on alumina can be resolved. You can measure devices whose performance could previously only be theorized. The 3680V, has excellent return loss and insertion loss from DC to 60 GHz. In a substrate measurement system, that translates to improved accuracy and repeatability, for more accurate characterization of your microstrip or CPW designs.

## Bias Capability

For active device measurements, the 3680 has bias capability either through the RF connection or through a bias probe. With optional multiple bias probes, you can inject bias into any point on your device under test. The bias probe provides infinite placement resolution and eliminates the need for external bias hardware. Alternately, if your active device is biased through an RF connection, bias tees can be used to combine bias and RF at any launch point. The 3680's flexible bias injection eliminates the need for multiple fixtures, saving you time and money. Up to four bias probes can be accommodated.

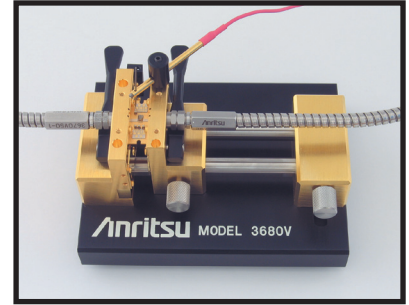

## MMIC Measurements

With the optional MMIC attachment, you can test MMIC's and very small components as conveniently as other devices. A MMIC attachment consists of a center carrier, with microstrip lines for launching, and cam-operated pressure rods. The MMIC component is placed on the center carrier between microstrip lines. (Machinable center carrier blocks are available for your custom designs.) Contact with the component is made with spring tabs, for reliability and damage protection. The unique design of the MMIC attachment assures solid, repeatable measurements on any small device. An Anritsu substrate measurement system can fulfill all your substrate measurement needs including, with a MMIC attachment, very small substrates and MMICs.

## Calibration/Verification Kits

A full complement of calibration kits for microstrip or coplanar waveguide are available. Standard Open Short Load (OSL) and Line Reflect Line (LRL) calibration components are included. The substrates for these cal kits are carefully selected for proper impedance and consistency, to provide the most accurate measurements possible. Included with every cal kit is a Beatty standard (standard mismatch) and a 20 dB offset termination. Now you can verify, in the fixture, the quality of your calibrations. This verification, available only from Anritsu, ensures the validity of your device measurements.



36804B-10M - 10 mil Microstrip Calibration/Verification kit



36804B-25C - 25 mil Microstrip Calibration/Verification kit



36804-25C - Coplanar Upper Jaws



# UNIVERSAL TEST FIXTURES

3680 Series DC to 60 GHz

## Specifications

3680 series Universal Test Fixture	Substrate types supported	Microstrip or coplanar waveguide
	Overall size	10 x 12.7 x 6.4 cm
	Substrate length	0.5 cm min. 5 cm max. [10 cm with 3680-20]
	Maximum substrate width	No limit
	Substrate thickness	0.012 cm min. 0.19 cm max.
	Maximum line offset	±1.2 cm [±2.5 cm with 3680-20]
	Input and output connectors	3680-20: APC-3.5™ female 3680K: K Connector® female 3680V: V Connector® female
36802 MMIC Attachment	Substrate thickness	0.0 cm, 0.038 cm, 0.064 cm
	Minimum test substrate length	1.5 mm
	Maximum test substrate length	1.17 cm with standard block
	Maximum line offset	±1.2 cm
36801 Right Angle Launcher	Distance from in-line connector, axial	Minimum: 1 cm Maximum: 4 cm
	Distance from in-line connector, offset	Minimum: 0.0 cm Maximum: 2 cm

## Electrical

Model	Universal Test Fixture			Right-Angle Launcher		MMIC Attachment
	3680-20	3680K	3680V	36801K	36801V	36802
Frequency range (GHz)	DC to 20	DC to 40	DC to 60	DC to 30	DC to 50	DC to 60
Return loss (dB)						
DC to 20 GHz	>17	>17	>17	>16	>16	>12
20 to 40 GHz		>14	>14	>12	>12	>8
40 to 60 GHz			>8		>7	>6
Repeatability (dB)						
DC to 20 GHz	<±0.10	<±0.10	<±0.10	<±0.15	<±0.15	<±0.20
20 to 40 GHz		<±0.20	<±0.20	<±0.25	<±0.25	<±0.40
40 to 60 GHz			<±0.30		<±0.40	<±0.60

Temperature range: -20° to 70°C

## Ordering information

Please specify model/order number, name and quantity when ordering.

Model/Order No.	Name
<b>Main frame</b>	
3680-20	Universal Test Fixture (20 GHz)
3680K	Universal Test Fixture (40 GHz)
3680V	Universal Test Fixture (60 GHz)
<b>Accessories</b>	
36801K	Right-Angle Launcher (30 GHz)
36801V	Right-Angle Launcher (50 GHz)
36802	MMIC Attachment
36803	Bias Probe
36805-10M	10 mil launchers <sup>①</sup>
36805-15M	15 mil launchers <sup>①</sup>
36805-25M	25 mil launchers <sup>①</sup>
<b>Calibration/verification kits</b>	
36804B-10M	10 mil microstrip cal/verif. kit, DC to 50 GHz
36804B-15M	15 mil microstrip cal/verif. kit, DC to 30 GHz
36804B-25M	25 mil microstrip cal/verif. kit, DC to 15 GHz
36804-25C	25 mil coplanar waveguide cal/verif. kit, DC to 20 GHz

<sup>①</sup> 36805 series includes (4) substrate launchers for the 36802 MMIC attachment

# LIMITERS

1 Series 1 MHz to 26.5 GHz

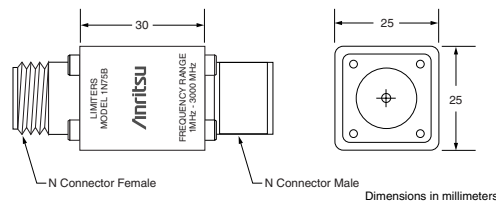

IN50B and IN75B Limiters outline

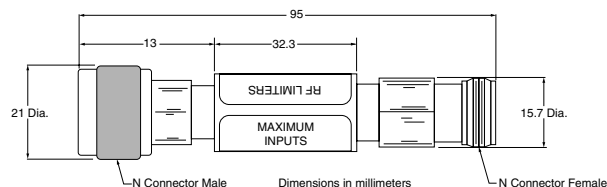

IN50C and IN75C Limiters outline

## Broadband microwave limiter features

- High power protection: Up to 5 Watts
- Very fast turn-on time: 10 ns max.
- Broad frequency range: 0.001 to 26.5 GHz
- Low insertion loss: 2.7 dB to 20 GHz
- Excellent return loss: 11 dB at 20 GHz
- Single side limiting

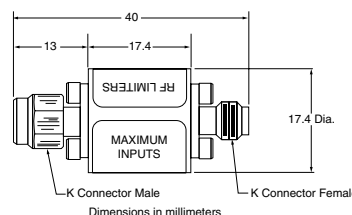

1K50A and 1K50B Limiters outline

## Specifications

Model	Frequency range	Max. input power	Min. return loss (at 0 dBm input)	Max. insertion loss (at 0 dBm input)	Max. turn-on time	Input connector	Output connector	Input/output coupling
1K50B	0.01 to 26.5 GHz	3 Watts	10 dB	3.9 dB	10 ns	K(m)	K(f)	DC
1K50A	0.01 to 20 GHz	5 Watts	14 dB, ≤12 GHz 11 dB, >12 GHz	2.7 dB	10 ns	K(m)	K(f)	DC
1N50C	0.01 to 18 GHz	5 Watts	14 dB, ≤12 GHz 11 dB, >12 GHz	2.9 dB	10 ns	N(m)	N(f)	DC
1N75C	0.01 to 3 GHz	5 Watts	15 dB	1.1 dB	10 ns	75 Ω N(m)	75 Ω N(f)	DC
1N50B	0.001 to 3 GHz	1.5 Watts	19 dB	1.3 dB	10 ns	N(m)	N(f)	AC
1N75B	0.001 to 3 GHz	1.5 Watts	19 dB	1.3 dB	10 ns	75 Ω N(m)	75 Ω N(f)	AC

**Limiting Level:** Limiter begins compressing at approximately +10 dBm. In compression, output level increases by 0.25 to 0.5 dB for each 1 dB increase at the input. Output power at 5W input at 500 MHz is 21 dBm max.

**Dimensions:** 1N50B and 1N75B 3.8 cm x 2.5 cm x 2.5 cm

**Temperature range:** 0°C to +70°C

## Ordering information

Please specify model/order number, name and quantity when ordering.

Model/Order No.	Name
	<b>Limiter</b>
1N50B	N(m) to N(f), 50 Ω, 1 MHz to 3 GHz
1N75B	N(m) to N(f), 75 Ω, 1 MHz to 3 GHz
1N50C	N(m) to N(f), 50 Ω, 10 MHz to 18 GHz
1N75C	N(m) to N(f), 75 Ω, 10 MHz to 3 GHz
1K50A	K(m) to K(f), 50 Ω, 10 MHz to 20 GHz
1K50B	K(m) to K(f), 50 Ω, 10 MHz to 26.5 GHz

# MATCHING PADS

12 Series DC to 3000 MHz



## Specifications

Model	Frequency range (MHz)	SWR	Insertion loss (dB)	Connectors
12N50-75B	DC to 3000	1.25	7.5 max.	N(m) 50 $\Omega$ to N(f) 75 $\Omega$

**Temperature range:** 0°C to +70°C

**Dimensions:** 3.8 cm x 2.5 cm x 2.5 cm

**Maximum Input Power:** 0.2 W

## Ordering information

Please specify model/order number, name and quantity when ordering.

Model/Order No.	Name
12N50-75B	Matching Pad, DC to 3000 MHz

## RF matching pad and impedance adapter features

- DC to 3000 MHz frequency range
- Matching pad matches 50  $\Omega$  to 75  $\Omega$  or 75  $\Omega$  to 50  $\Omega$  circuits

The 12N50-75B matching pad is a two-resistor design that matches 50  $\Omega$  to 75  $\Omega$  or 75  $\Omega$  to 50  $\Omega$  circuits.

# VNA AND VNMS CALIBRATION KITS



3651A Option 1



3654D

The Anritsu Calibration Kits contain all the precision components and tools required to calibrate your VNA or VNMS for 12-term error-corrected measurements in the connector style of your choice. Components are included for calibrating male and female test ports as required. The kits support calibration with opens, shorts, and broadband loads. Option 1 adds sliding terminations and a pin depth gauge where required.

**The following kits are for use with 37xxx Lightning VNAs, MS464xB VectorStar, ShockLine Series VNAs and MS20xxx VNA Master.**

### 3650A SMA/3.5 mm Calibration Kit consisting of:

- 33SFSF50 Female-Female Adapter (2)\*
- 33SS50 Male-Male Adapter\*
- 28S50-2 Broadband Male Termination (2)
- 28SF50-2 Broadband Female Termination (2)
- 33SSF50 Male-Female Adapter (2)\*
- 24S50 Male Open
- 24SF50 Female Open
- 23S50 Male Short
- 23SF50 Female Short
- Connector Thumb Wheel (4)
- 01-201 Torque Wrench
- 01-210 Reference Flat
- 01-222 Pin Depth Gauge
- 01-223 Pin Depth Gauge
- Calibration coefficients diskette
- Calibration coefficients memory stick

#### Option 1

##### Adds the following:

- 17SF50 Female Sliding Termination
- 17S50 Male Sliding Termination

### 3651A GPC-7 Calibration Kit consisting of:

- 28A50-2 Broadband Termination (2)
- 24A50 Open
- 23A50 Short
- 01-200 Torque Wrench
- 01-221 Collet Extractor Tool and 4 Collets
- Calibration coefficients diskette
- Calibration coefficients memory stick

#### Option 1

##### Adds the following:

- 17A50 Sliding Termination
- 01-210 Reference Flat
- 01-220 Pin Depth Gauge

### 3652A K Connector® Calibration Kit consisting of:

- 33KFKF50B Female-Female Adapter (2)\*
- 33KK50B Male-Male Adapter\*
- 28K50A Broadband Male Termination (2)
- 28KF50A Broadband Female termination (2)
- 33KKF50B Male-Female Adapter (2)\*
- 24K50 Male Open
- 24KF50 Female Open
- 23K50 Male Short
- 23KF50 Female Short
- 01-201 Torque Wrench
- 01-210 Reference Flat
- 01-222 Pin Depth Gauge
- 01-223 Pin Depth Gauge
- Calibration coefficients diskette
- Connector thumb wheel (4)
- Calibration coefficients memory stick

#### Option 1

##### Adds the following:

- 17KF50 Female Sliding Termination
- 17K50 Male Sliding Termination

#### Option 2

##### Removes the following:

- 01-222 Pin Depth Gauge
- 01-223 Pin Depth Gauge

#### Option 3

##### Adds the following:

- .s1p Database calibration

#### Option 4

##### Adds the following:

- .s1p Database calibration

##### Removes the following:

- 01-222 Pin Depth Gauge
- 01-223 Pin Depth Gauge

### 3653A Type N Calibration Kit consisting of:

- 23NF50 Female Short
- 23N50 Male Short
- 24NF50 Female Open
- 24N50 Male Open
- 28N50-2 Broadband Male Termination (2)
- 28NF50-2 Broadband Female Termination (2)
- 34AN50-2 Male Adapter (2)
- 34ANF50-2 Female Adapter (2)
- 01-213 Reference Gauge
- 01-224 Pin Depth Gauge
- Calibration coefficients diskette
- Calibration coefficients memory stick

# VNA AND VNMS CALIBRATION KITS

The following kits are recommended for use with 37xxx Lightning and MS464xB VectorStar.

## 3654D V Connector® Calibration Kit consisting of:

- 23V50C-5.1 Male Short 5.1mm
- 23VF50C-5.1 Female Short 5.1mm
- 24V50C Male Open
- 24VF50C Female Open
- 28V50D Male Broadband Termination (2)
- 28VF50D Female Broadband Termination (2)
- 33VV50C Male-Male Adapter\*
- 33VVF50C Female-Female Adapter (2)\*
- 33VVF50C Male-Female Adapter (2)\*
- Calibration coefficients diskette
- Connector thumb wheel (4)
- 01-201 Torque Wrench
- 01-210 Reference Flat
- 01-322 Pin Depth Gauge
- 01-323 Female Adapter for pin gauge
- 01-204 Adapter Wrench
- 01-312 Male Flush Short
- 01-311 Female Flush Short
- Calibration coefficients memory stick

### Option 1

#### Adds the following:

- 17VF50C Female Sliding Load
- 17V50C Male Sliding Load

### Option 2

#### Removes the following:

- 01-322 Pin Depth Gauge
- 01-323 Pin Depth Gauge

### Option 3

#### Adds the following:

- .s1p Database calibration

### Option 4

#### Adds the following:

- .s1p Database calibration

#### Removes the following:

- 01-322 Pin Depth Gauge
- 01-323 Pin Depth Gauge

The following kits are recommended for use with and MS464xB VectorStar and ShockLine MS46522B-082

## 3655 Series Waveguide Calibration Kit

The 3655 Series Calibration Kit contains all of the precision components and tools required to calibrate your VNA for 12-term error-corrected measurement. The 3655E Series is available for WR-10, WR-12 and WR-15 EIA waveguide frequencies. Components are included for calibrating both module ports. The kit supports calibration with offset shorts and broadband loads. Option 1 adds a sliding termination.

### Consisting of:

- Short, Flush (2)
- Offsets, 1/8 and 3/8 Wavelength
- Terminations, Fixed (2)
- Test Port Sections (2)

### Option 1

#### Adds the following:

- Sliding Termination

The following kits are recommended for use with MS464xB VectorStar.

## 3659 0.8 mm Calibration/Verification Kit Consisting of:

- 28.850 Male Broadband Termination
- 24.850 Male Open
- 23.850-3 Male Offset Short 3
- 23.850-2 Male Offset Short 2
- 23.850-1 Male Offset Short 1
- 28.8F50 Female Broadband Termination
- 24.8F50 Female Open

- 23.8F50-3 Female Offset Short 3
- 23.8F50-2 Female Offset Short 2
- 23.8F50-1 Female Offset Short 1
- 33W.8F50 W1M-0.8F Adapter
- 33W.850 W1M-0.8M Adapter
- 33WF.8F50 W1F-0.8F Adapter
- 33WF.850 W1F-0.8M Adapter
- 33.8F.8F50 0.8 Female-Female Adapter
- 33.8.8F50 0.8 Male-Female Adapter
- 33.8.850 0.8 Male-Male Adapter
- 18.8.8F50-1B Stepped Impedance Mismatch Thru Line (Verification Device)
- 18.8.8F50-1 50 Ohm Matched Thru Line (Verification Device)
- 01-525 6 mm / 7 mm End Wrench
- 01-524 6 mm Torque Wrench
- USB Memory Device containing Calibration Coefficient and Verification Data

## 3656B W1 Calibration Kit consisting of:

- 23W50-1 Male Offset Short (2.02 mm)
- 23W50-2 Male Offset Short (2.65 mm)
- 23W50-3 Male Offset Short (3.180 mm)
- 24W50 Male Open (1.510 mm)
- 28W50 Male Broadband Termination
- 23WF50-1 Female Offset Short 1 (2.02 mm)
- 23WF50-2 Female Offset Short 2 (2.65 mm)
- 23WF50-3 Female Offset Short 3 (3.180 mm)
- 28WF50 Female Broadband Termination
- 24WF50 Female Open (1.930 mm)
- 33WSC50 Fixed Male SC Connector
- 33WFSC50 Fixed Female SC Connector
- Interchangeable Sliders, SC Connectors
- Locking Keys, SC Connectors
- 01-402 Interchange Adapter Fixed Male
- 33WWF50 Male-Female Adapter
- 33WW50 Male-Male Adapter
- 33WFWF50 Female-Female Adapter
- 01-504 6 mm Torque Wrench
- 01-505 6-7 mm End Wrench
- 18WFWF50-1B Stepped Impedance Thru Line (Verification Device)
- 18WFWF50-1 50Ω Matched Thru Line (Verification Device)
- Calibration coefficients diskette
- Calibration coefficients memory stick

## Ordering information

Please specify model/order number, name and quantity when ordering.

Model/Order No.	Name
	<b>Calibration kits</b>
3650A	SMA/3.5 mm calibration kit
Option 1	Adds sliding terminations
3651A	GPC-7 calibration kit
Option 1	Adds sliding terminations
3652A	K Connector® calibration kit
Option 1	Adds sliding terminations
Option 2	Adds Pin Depth Gauge
Option 3	Adds .s1p Database calibration
Option 4	Adds .s1p Database calibration Removes Pin Depth Gauge
3653A	Type N calibration kit
3654D	V Connector® calibration kit
Option 1	Adds sliding terminations
Option 2	Adds Pin Depth Gauge
Option 3	Adds .s1p Database calibration
Option 4	Adds .s1p Database calibration Removes Pin Depth Gauge
3655E	WR12 Waveguide calibration kit
Option 1	Adds sliding terminations
3655V	WR15 Waveguide calibration kit
Option 1	Adds sliding terminations
3655W	WR10 Waveguide calibration kit
Option 1	Adds sliding terminations
3656B	W1 calibration kit
3659	0.8 mm Calibration/Verification Kit

\* Phase Equal Adapters

# VNA AND VNMS VERIFICATION KITS



3669B

The Anritsu Verification Kits contain precision components with characteristics that are traceable to NIST. Used primarily by the metrology laboratory, these components provide the most dependable means of determining the system accuracy of your VNA. A disk containing factory measured test data for all components is supplied for comparison with customer-measured data.

The following kits are for use with 37XXX Lightning VNAs.

### 3663 Type N Verification Kit consisting of:

- 42N-50, 50 dB Attenuator
- 18N50-10, 10 cm Airline
- 42N20, 20 dB Attenuator
- 18N50-10B, 10 cm Stepped Impedance Airline (Beatty standard)
- Verification kit disks

### 3666 SMA/3.5 mm Verification Kit consisting of:

- 19S50-7, 7.5 cm Airline
- 19S50-7B, 7.5 cm Stepped Impedance Airline (Beatty standard)
- 42S-50, 50 dB Attenuator
- 42S-20, 20 dB Attenuator
- Verification kit disks

### 3667 GPC-7 Verification Kit consisting of:

- 42A-50, 50 dB Attenuator
- 18A50-10, 10 cm Airline
- 42A-20, 20 dB Attenuator
- 18A50-10B, 10 cm Stepped Impedance Airline (Beatty standard)
- Verification kit disks

### 3668 K Connector® Verification Kit consisting of:

- 19K50-7, 7.5 cm Airline
- 42K-50, 50 dB Attenuator
- 42K-20, 20 dB Attenuator
- 19K50-7B, 7.5 cm Stepped Impedance Airline (Beatty standard)
- Verification kit disks

### 3669B V Connector® Verification Kit consisting of:

- 42V-40, 40 dB Attenuator
- 42V-20, 20 dB Attenuator
- 19V50-5, 5 cm Airline
- 19V50-5B, 5 cm Stepped Impedance Airline (Beatty standard)
- Verification kit disks

## Ordering information

Please specify model/order number, name and quantity when ordering.

Model/Order No.	Name
	<b>Verification kits</b>
3663	Type N verification kit
3666	SMA/3.5 mm verification kit
3667	GPC-7 verification kit
3668	K Connector® verification kit
3669B	V Connector® verification kit

The following kits are for use with MS464xB VectorStar™ VNAs.

### 3666- I 3.5 mm Verification Kit consisting of:

- 19S50-7, 7.5 cm Airline
- 19S50-7B, 7.5 cm Stepped Impedance Airline (Beatty standard)
- 42S-20, 20 dB Offset Attenuator
- 42S-50, 50 dB Offset Attenuator
- USB memory device
- CD, software and documentation

### 3668- I K Verification Kit consisting of:

- 19K50-7, 7.5 cm Airline
- 19K50-7B, 7.5 cm Stepped Impedance Airline (Beatty standard)
- 42K-20, 20 dB Offset Attenuator
- 42K-50, 50 dB Offset Attenuator
- USB memory device
- CD, software and documentation

### 3669B- I V Verification Kit consisting of:

- 19V50-5, 5 cm Airline
- 19V50-5B, 5 cm Stepped Impedance Airline (Beatty standard)
- 42V-20, 20 dB Offset Attenuator
- 42V-50, 50 dB Offset Attenuator
- USB memory device
- CD, software and documentation

## Ordering information

Please specify model/order number, name and quantity when ordering.

Model/Order No.	Name
	<b>Verification kits</b>
3666-1	3.5 mm verification kit
3668-1	K verification kit
3669B-1	V verification kit

# PART NUMBER INDEX

Item	Description	Page	Item	Description	Page
01-101A	K Connector Evaluation Kit .....	8	28S50-1	Termination, 3.5mm(m) .....	35
01-103	Soldering Fixture for sparkplug launcher glass beads, package of 10 .....	8	28SF50-1	Termination, 3.5mm(f) .....	35
01-104	Drill and Tap Set for K Connectors.....	8	28V50D	Termination, V(m).....	35
01-105A	Male and Female Sparkplug Torquing Kit.....	8, 13	28VF50D	Termination, V(f).....	35
01-106	K Soldering Fixture for flange launcher glass bead, package of 5 .....	8	28W50	Termination, W1(m).....	35
01-107F	Cable Sleeve Soldering Fixture for K101F Female Cable Connectors, package of 10 .....	8	28WF50	Termination, W1(f).....	35
01-107M	Cable Sleeve Soldering Fixture for K101M Male Cable Connectors, package of 10 .....	8	33.8.850	Calibration Grade Adapter, DC to 145 GHz, 0.8 mm (m) to 0.8 mm (m) .....	27
01-108	Drill and Tap Set for K Connector with Sliding Contacts .....	8	33.8.8F50	Calibration Grade Adapter, DC to 145 GHz, 0.8 mm (m) to 0.8 mm (f) .....	27
01-118	K Connector Cable Assembling Fixture Kit for K 118 semi-rigid coaxial cable.....	8	33.8F.8F50	Calibration Grade Adapter, DC to 145 GHz, 0.8 mm (f) to 0.8 mm (f) .....	27
01-201	Torque wrench for SMA, 3.5 mm and K Connectors.....	8, 13	33KFKF50B	Calibration Grade Adapter, DC to 40 GHz, K(f) to K(f).....	26
01-204	Handy wrench for SMA, 3.5 mm, K, 2.4 mm and V Connectors .....	8, 13	33KK50B	Calibration Grade Adapter, DC to 40 GHz, K(m) to K(m) .....	26
01-301	V Connector Evaluation Kit .....	12	33KKF50B	Calibration Grade Adapter, DC to 40 GHz, K(m) to K(f).....	26
01-303	Soldering Fixture for V sparkplug launcher glass beads, package of 10 .....	12	33NFnF50B	Calibration Grade Adapter, DC to 18 GHz, N(f) to N(f).....	25
01-304	Drill and Tap Set for V connectors.....	12	33NN50B	Calibration Grade Adapter, DC to 18 GHz, N(m) to N(m) .....	25
01-306	Soldering fixture for flange launcher glass bead.....	13	33NNF50B	Calibration Grade Adapter, DC to 18 GHz, N(m) to N(f).....	25
01-307F	Cable sleeve soldering fixture, female connector .....	13	33SFSF50	Calibration Grade Adapter, DC to 26.5 GHz, WSMA(f) to WSMA(f) .....	25
01-307M	Cable sleeve soldering fixture, male connector .....	13	33SS50	Calibration Grade Adapter, DC to 26.5 GHz, WSMA(m) to WSMA(m) .....	25
01-308	Drill and Tap set.....	13	33SSF50	Calibration Grade Adapter, DC to 26.5 GHz, WSMA(m) to WSMA(f) .....	25
01-309	V Connector Cable Assembling Fixture Kit .....	13	33VFVF50C	Calibration Grade Adapter, DC to 70 GHz, V(f) to V(f).....	26
01-504	W1 6 mm Torque Wrench.....	16	33VV50C	Calibration Grade Adapter, DC to 70 GHz, V(m) to V(m) .....	26
01-505	W1 6-7mm Open end Wrench.....	16	33VVF50C	Calibration Grade Adapter, DC to 70 GHz, V(m) to V(f).....	26
01-506	W1 7 mm Torque Wrench.....	16	33W.850	Calibration Grade Adapter, DC to 110 GHz, W1 (m) to 0.8 mm (m).....	27
11N50B	RF Power Divider, 1 MHz to 3 GHz.....	47	33W.8F50	Calibration Grade Adapter, DC to 110 GHz, W1 (m) to 0.8 mm (f) .....	27
12N50-75B	Matching Pad, N(m) 50 Ω to N(f) 75 Ω.....	65	33WF.850	Calibration Grade Adapter, DC to 110 GHz, W1 (f) to 0.8 mm (m) .....	27
18A50	Air Line, GPC-7.....	41	33WF.8F50	Calibration Grade Adapter, DC to 110 GHz, W1 (f) to 0.8 mm (f) .....	27
18N50	Air Line, N(m) .....	41	33WFWF50	Calibration Grade Adapter, DC to 110 GHz, W1(f) to W1(f).....	26
18NF50	Air Line, N(f) .....	41	33WW50	Calibration Grade Adapter, DC to 110 GHz, W1(m) to W1(m) .....	26
19S50	Air Line, WSMA(m) .....	41	33WWF50	Calibration Grade Adapter, DC to 110 GHz, W1(m) to W1(f).....	26
19SF50	Air Line, WSMA(f) .....	41	34AN50	Adapter, DC to 18 GHz, GPC-7 to N(m).....	29
1K50A	Limiter, K, 0.01 to 20 GHz.....	64	34ANF50	Adapter, DC to 18 GHz, GPC-7 to N(f).....	29
1K50B	Limiter, K, 0.01 to 26.5 GHz.....	64	34AS50	Adapter, DC to 18 GHz, GPC-7 to WSMA(m).....	29
1N50B	Limiter, N, 0.01 to 3 GHz.....	64	34ASF50	Adapter, DC to 18 GHz, GPC-7 to WSMA(f).....	29
1N50C	Limiter, N, 0.01 to 18 GHz.....	64	34NFK50	Adapter, DC to 18 GHz, N(f) to K(m).....	29
1N75B	Limiter, 75 Ω N, 0.01 to 3 GHz .....	64	34NFKF50	Adapter, DC to 18 GHz, N(f) to K(f).....	29
1N75C	Limiter, 75 Ω N, 0.01 to 3 GHz.....	64	34NFNF50	Adapter, DC to 18 GHz, N(f) to N(f).....	29
22K50	Open/Short, K(m) .....	42	34NK50	Adapter, DC to 18 GHz, N(m) to K(m) .....	29
22KF50	Open/Short, K(f) .....	42	34NKF50	Adapter, DC to 18 GHz, N(m) to K(f) .....	29
22N50	Open/Short, N(m) .....	42	34NN50A	Adapter, DC to 18 GHz, N(m) to N(m) .....	29
22N75	Open/Short, 75 Ω N(m).....	42	34NN75B	Adapter, DC to 3 GHz, 75 Ω N(m) to 75 Ω N(m).....	29
22NF50	Open/Short, N(f) .....	42	34RKNF50	Ruggedized Adapter, DC to 18 GHz, RK to N(f).....	29
22NF75	Open/Short, 75 Ω N(f).....	42	34RKRK50	Ruggedized Adapter, DC to 40 GHz, RK to RK .....	29
22S50	Open/Short, WSMA(m) .....	42			
22SF50	Open/Short, WSMA(f) .....	42			
22V50	Open/Short, V(m) .....	42			
22VF50	Open/Short, V(f) .....	42			
28.850	Termination, 0.8 mm(m) .....	35			
28.8F50	Termination, 0.8 mm(f) .....	35			
28A50-1	Termination, GPC-7 .....	35			
28K50A	Termination, K(m) .....	35			
28KF50A	Termination, K(f).....	35			
28L50R	Termination, 3.5 mm(m) .....	35			
28LF50R	Termination, 3.5 mm(f) .....	35			
28N50-2	Termination, N(m) .....	35			
28N50-3	Termination, N(m).....	35			
28NF50-2	Termination, N(f).....	35			

# PART NUMBER INDEX

Item	Description	Page	Item	Description	Page
34RSN50	Ruggedized Adapter, DC to 18 GHz, RS to N(m).....	29	3670NN50-2	N(m) to N(m), 2 Foot, Armored Semi-rigid Cable.....	22
34RVNF50	Ruggedized Adapter, DC to 18 GHz, RV to N(f).....	29	3670V50A-1	V(m) to V(f), 1 Foot, Armored Semi-rigid Cable.....	22
34RVRK50	Ruggedized Adapter, DC to 40 GHz, RV to RK.....	29	3670V50A-2	V(m) to V(f), 2 Foot, Armored Semi-rigid Cable.....	22
34RVRV50	Ruggedized Adapter, DC to 60 GHz, RV to RV.....	29	36801K	Universal Test Fixture Accessories, Right-Angle Launcher (40 GHz).....	61
34SFSF50	Adapter, DC to 26.5 GHz, WSMA(f) to WSMA(f).....	29	36801V	Universal Test Fixture Accessories, Right-Angle Launcher (60 GHz).....	61
34VFK50	Adapter, DC to 40 GHz, V(f) to K(m).....	23	36802	Universal Test Fixture Accessories, MMIC Attachment.....	61
34VFKF50	Adapter, DC to 40 GHz, V(f) to K(f).....	23	3680-20	Universal Test Fixture Main frame (20 GHz).....	61
34VVF50	Adapter, DC to 65 GHz, V(f) to V(f).....	23	36803	Universal Test Fixture Accessories, Bias Probe.....	61
34VK50	Adapter, DC to 40 GHz, V(m) to K(m).....	23	36804-25C	Universal Test Fixture Calibration/verification kits, 25 mil coplanar waveguide.....	61
34VKF50	Adapter, DC to 40 GHz, V(m) to K(f).....	23	36804B-10M	Universal Test Fixture Calibration/verification kits, 10 mil microstrip.....	61
34VV50	Adapter, DC to 65 GHz, V(m) to V(m).....	23	36804B-15M	Universal Test Fixture Calibration/verification kits, 15 mil microstrip.....	61
34VVF50	Adapter, DC to 65 GHz, V(m) to V(f).....	23	36804B-25M	Universal Test Fixture Calibration/verification kits, 25 mil microstrip.....	61
34WV50	Adapter, DC to 65 GHz, V(m) to V(f).....	23	36805-10M	Universal Test Fixture Accessories, 10 mil launchers.....	61
34WFV50	Adapter, W1(f) to V(m), DC to 65 GHz,.....	30	36805-15M	Universal Test Fixture Accessories, 15 mil launchers.....	61
34WV50	Adapter, W1(m) to V(m), DC to 65 GHz.....	30	36805-25M	Universal Test Fixture Accessories, 25 mil launchers.....	61
34WVF50	Adapter, W1(m) to V(f), DC to 65 GHz.....	30	3680K	Universal Test Fixture Main frame (40 GHz).....	61
35WR10W	WG/Coax Adapter, WR 10 to W1(m).....	31	3680V	Universal Test Fixture Main frame (60 GHz).....	61
35WR10WF	WG/Coax Adapter, WR 10 to W1(f).....	31	41KB-10	Precision Fixed Attenuator, 10 dB, 26.5 GHz.....	37
35WR15V	WG/Coax Adapter, WR15 to V(m).....	31	41KB-20	Precision Fixed Attenuator, 20 dB, 26.5 GHz.....	37
35WR15VF	WG/Coax Adapter, WR15 to V(f).....	31	41KB-3	Precision Fixed Attenuator, 3 dB, 26.5 GHz.....	37
35WR19K	WG/Coax Adapter, WR19 to K(m).....	31	41KB-6	Precision Fixed Attenuator, 6 dB, 26.5 GHz.....	37
35WR19KF	WG/Coax Adapter, WR19 to K(f).....	31	41KB-S	Precision Fixed Attenuator Set, 26.5 GHz.....	37
35WR19V	WG/Coax Adapter, WR19 to V(m).....	31	41KC-10	Precision Fixed Attenuator, 10 dB, 40 GHz.....	37
35WR19VF	WG/Coax Adapter, WR19 to V(f).....	31	41KC-20	Precision Fixed Attenuator, 20 dB, 40 GHz.....	37
35WR22K	WG/Coax Adapter, WR22 to K(m).....	31	41KC-3	Precision Fixed Attenuator, 3 dB, 40 GHz.....	37
35WR22KF	WG/Coax Adapter, WR22 to K(f).....	31	41KC-6	Precision Fixed Attenuator, 6 dB, 40 GHz.....	37
35WR22V	WG/Coax Adapter, WR22 to V(m).....	31	41KC-S	Precision Fixed Attenuator Set, 40 GHz.....	37
35WR22VF	WG/Coax Adapter, WR22 to V(f).....	31	41V-10	Precision Fixed Attenuator, 10 dB, 60 GHz.....	37
35WR28K	WG/Coax Adapter, WR28 to K(m).....	31	41V-20	Precision Fixed Attenuator, 20 dB, 60 GHz.....	37
35WR28KF	WG/Coax Adapter, WR28 to K(f).....	31	41V-3	Precision Fixed Attenuator, 3 dB, 60 GHz.....	37
35WR42K	WG/Coax Adapter, WR42 to K(m).....	31	41V-6	Precision Fixed Attenuator, 6 dB, 60 GHz.....	37
35WR42KF	WG/Coax Adapter, WR42 to K(f).....	31	41V-S	Precision Fixed Attenuator Set, 60 GHz.....	37
35WRD180K	WG/Coax Adapter, WRD180 to K(m).....	31	43KB-10	Fixed Attenuator, 10 dB, 26.5 GHz.....	37
35WRD180KF	WG/Coax Adapter, WRD 180 to K(f).....	31	43KB-20	Fixed Attenuator, 20 dB, 26.5 GHz.....	37
3650A	Calibration Kit, SMA/3.5 mm.....	66	43KB-3	Fixed Attenuator, 3 dB, 26.5 GHz.....	37
3651A	Calibration Kit, GPC-7.....	66	43KB-6	Fixed Attenuator, 6 dB, 26.5 GHz.....	37
3652A	Calibration Kit, K Connector.....	66	43KC-10	Fixed Attenuator, 10 dB, 40 GHz.....	37
3653A	Calibration Kit, Type N.....	66	43KC-20	Fixed Attenuator, 20 dB, 40 GHz.....	37
3654D	Calibration Kit, V Connector.....	67	43KC-3	Fixed Attenuator, 3 dB, 40 GHz.....	37
3655E	Calibration Kit, WR12 Waveguide.....	67	43KC-6	Fixed Attenuator, 6 dB, 40 GHz.....	37
3655V	Calibration Kit, WR15 Waveguide.....	67	4412K	Step Attenuator, DC to 20 GHz, 70 dB.....	39
3655W	Calibration Kit, WR10 Waveguide.....	67	4422K	Step Attenuator, DC to 20 GHz, 110 dB.....	39
3656B	Calibration Kit, W1 Connector.....	67	4512K	Step Attenuator, DC to 26.5 GHz, 70 dB.....	39
3663	Verification Kit, Type N.....	68	4522K	Step Attenuator, DC to 26.5 GHz, 110 dB.....	39
3666	Verification Kit, SMA/3.5 mm.....	68	4612K	Step Attenuator, DC to 40 GHz, 70 dB.....	39
3666-1	Verification Kit, 3.5 mm.....	68	4622K	Step Attenuator, DC to 40 GHz, 110 dB.....	39
3667	Verification Kit, GPC-7.....	68	70KA50	Detector, K(m), 0.01 to 20 GHz.....	45
3668	Verification Kit, K Connector.....	68	70KC50	Detector, K(m), 0.01 to 40 GHz.....	45
3668-1	Verification Kit, K Connector.....	68	75KC50	Detector, K(m), 0.01 to 40 GHz.....	45
3669B	Verification Kit, V Connector.....	68	75N50B	Detector, N(m), 0.01 to 18 GHz.....	45
3669B-1	Verification Kit, V Connector.....	68	75VA50	Detector, V(m), 0.01 to 50 GHz.....	45
3670.850-1	0.8 mm(m) to 0.8 mm(f), 10 cm, Armored Semi-rigid Cable.....	22	K101F-R	K Female In-Line Cable Connector, DC to 40 GHz for 3.00 mm K118 cable.....	9
3670.850-2	0.8 mm(m) to 0.8 mm(f), 16 cm, Armored Semi-rigid Cable.....	22			
3670A50-2	GPC-7, 2 Foot, Armored Semi-rigid Cable.....	22			
3670K50-1	K(m) to K(f), 1 Foot, Armored Semi-rigid Cable.....	22			
3670K50-2	K(m) to K(f), 2 Foot, Armored Semi-rigid Cable.....	22			
3670KF50-1	K(f) to K(f), 1 Foot, Armored Semi-rigid Cable.....	22			
3670KF50-2	K(f) to K(f), 2 Foot, Armored Semi-rigid Cable.....	22			
3670N50-1	N(m) to N(f), 1 Foot, Armored Semi-rigid Cable.....	22			
3670N50-2	N(m) to N(f), 2 Foot, Armored Semi-rigid Cable.....	22			
3670NN50-1	N(m) to N(m), 1 Foot, Armored Semi-rigid Cable.....	22			



# PART NUMBER INDEX

Item	Description	Page	Item	Description	Page
K101M-R	K Male In-Line Cable Connector, DC to 40 GHz for 3.00 mm K118 cable .....	9	S110-3	Microstrip and coplanar waveguide stress relief contact for 0.38 mm glass feedthru center conductor .....	10
K101M-085-R	K Male In-Line Cable Connector, DC to 40 GHz for 2.18 mm V085 cable .....	9	TOSLK50A-20	Thru/Open/Short/Load, K(m), DC to 20 GHz, 50 Ω .....	44
K102F-R	K Female Sparkplug Launcher Connector, DC to 40 GHz .....	9	TOSLK50A-40	Thru/Open/Short/Load, K(m), DC to 40 GHz, 50 Ω .....	44
K102M-R	K Male Sparkplug Launcher Connector, DC to 40 GHz .....	9	TOSLKF50A-20	Thru/Open/Short/Load, K(f), DC to 20 GHz, 50 Ω .....	44
K103F-R	K Female Flange Launcher, two-hole, DC to 40 GHz .....	9	TOSLKF50A-40	Thru/Open/Short/Load, K(f), DC to 40 GHz, 50 Ω .....	44
K103M-R	K Male Flange Launcher, two-hole, DC to 40 GHz .....	9	TOSLN50A-8	Thru/Open/Short/Load, N(m), DC to 8 GHz, 50 Ω .....	44
K104F-R	K Female Flange Launcher, four-hole, DC to 40 GHz .....	9	TOSLN50A-18	Thru/Open/Short/Load, N(m), DC to 18 GHz, 50 Ω .....	44
K104M-R	K Male Flange Launcher, two-hole, DC to 40 GHz .....	9	TOSLNF50A-8	Thru/Open/Short/Load, N(f), DC to 8 GHz, 50 Ω .....	44
K110-1	Stress relief Contact, Microstrip and Coplanar for 0.38 mm glass feedthru center conductor .....	10	TOSLNF50A-18	Thru/Open/Short/Load, N(f), DC to 18 GHz, 50 Ω .....	44
K110-3	Stress relief Contact, Microstrip and Coplanar for 0.38 mm glass feedthru center conductor .....	10	V085	1.52 m length of 2.18 mm semi-rigid cable for V101 series connector .....	13
K110-1-R	Stress relief Contact, Microstrip and Coplanar Waveguide .....	10	V101F-R	V Female In-Line Cable Connector, DC to 65 GHz for V085 cable .....	14
K110-2-R	Stress relief Contact, Stripline .....	10	V101M-R	V Male In-Line Cable Connector, DC to 65 GHz for V085 cable .....	14
K110-3-R	Stress relief Contact, Microstrip .....	10	V102F-R	V Female Sparkplug Launcher Connector, DC to 65 GHz .....	14
K118	1.5 m length of 3.00 mm semi-rigid cable for K101 series connector .....	8	V102M-R	V Male Sparkplug Launcher Connector, DC to 65 GHz .....	14
K120FF	Semi-rigid Cable, K(f) to K(f), DC to 40 GHz .....	19	V103F-R	V Female Flange Launcher, two-hole, DC to 65 GHz .....	14
K120MF	Semi-rigid Cable, K(m) to K(f), DC to 40 GHz .....	19	V103F-012	V(f) flange launcher, 2 mounting holes for 0.30 mm glass bead pin, DC to 65 GHz .....	14
K120MM	Semi-rigid Cable, K(m) to K(m), DC to 40 GHz .....	19	V103M-R	V Male Flange Launcher, two-hole, DC to 65 GHz .....	14
K210	Coaxial Termination, K(m) .....	36	V103M-012	V(m) flange launcher, 2 mounting holes for 0.30 mm glass bead pin, DC to 65 GHz .....	14
K220B	Adapter, K(m) to K(m) .....	23	V110-1-R	Stress Relief Contact for Microstrip and Coplanar Waveguide .....	13
K222B	Adapter, K(f) to K(f) .....	23	V120FF	Semi-rigid Cable, V(f) to V(f), DC to 65 GHz .....	19
K224B	Adapter, K(f) to K(m) .....	23	V120MF	Semi-rigid Cable, V(m) to V(f), DC to 65 GHz .....	19
K230B	Panel Mount Adapter, K(m) to K(m) .....	24	V120MM	Semi-rigid Cable, V(m) to V(m), DC to 65 GHz .....	19
K232B	Panel Mount Adapter, K(f) to K(f) .....	24	V210	Coaxial Termination, V(m) .....	36
K234B	Panel Mount Adapter, K(f) to K(m) .....	24	V230	Panel Mount Adapter, V(m) to V(m) .....	24
K240B	Precision Power Divider, DC to 26.5 GHz .....	48	V232	Panel Mount Adapter, V(f) to V(f) .....	24
K240C	Precision Power Divider, DC to 40 GHz .....	48	V234	Panel Mount Adapter, V(f) to V(m) .....	24
K241B	Power Splitter, DC to 26.5 GHz .....	49	V240C	Precision Power Divider, DC to 65 GHz .....	48
K241C	Power Splitter, DC to 40 GHz .....	49	V241C	Power Splitter, DC to 65 GHz .....	49
K250	Bias Tee, 0.1 to 40 GHz .....	51	V250	Bias Tee, 0.1 to 60 GHz .....	51
K251	Bias Tee, 50 kHz to 40 GHz .....	52	V251	Bias Tee, 100 kHz to 65 GHz .....	52
K252	Kelvin Bias Tee, 0.1 to 40 GHz .....	56	V252	Kelvin Bias Tee, 0.1 to 65 GHz .....	56
K261	Precision DC Block, 50 kHz to 40 GHz .....	57	V255	Ultra-Wideband Bias Tee, 50 kHz to 65 GHz .....	54
N120-6	Semi-rigid Cable, N(m) to N(m), DC to 18 GHz, 15.2 cm .....	19	V261	Precision DC Block, 100 kHz to 65 GHz .....	57
N241A50	Power Splitter, DC to 3000 MHz .....	50	V265	DC Block, 50 kHz to 65 GHz .....	59
NS120MF-6	Semi-rigid Cable, N(m) to SMA(f), DC to 18 GHz, 15.2 cm .....	19	W047-2	Semi-rigid Coaxial Cable .....	17
OSLK50	Open/Short/Load, DC to 20 GHz, K(m), 50 Ω .....	43	W1-101F	W1(f) In-line Cable Connector, DC to 110 GHz .....	16
OSLKF50	Open/Short/Load, DC to 20 GHz, K(f), 50 Ω .....	43	W1-101M	W1(m) In-line Cable Connector, DC to 110 GHz .....	16
OSLN50	Open/Short/Load, DC to 18 GHz, N(m), 50 Ω .....	43	W1-102F	W1(f) Sparkplug Connector, Hermetic, DC to 110 GHz .....	17
OSLN50-1	Open/Short/Load, DC to 6 GHz, N(m), 50 Ω .....	43	W1-102M	W1(m) Sparkplug Connector, Hermetic, DC to 110 GHz .....	16
OSLNF50	Open/Short/Load, DC to 18 GHz, N(f), 50 Ohm .....	43	W1-103F	W1(f) Flange Connector, DC to 110 GHz .....	17
OSLNF50-1	Open/Short/Load, DC to 6 GHz, N(f), 50 Ω .....	43	W1-105F	W1(f) Sparkplug Connector, DC to 110 GHz .....	17
S110-1	Microstrip and coplanar waveguide stress relief contact for 0.38 mm glass feedthru center conductor .....	10	W1-105M	W1(m) Sparkplug Connector, DC to 110 GHz .....	16

# NOTES

# POWER CONVERSION TABLE

Power (dBm)	P (mW)	Volts ms into 50 Ω	Volts Peak	Volts Peak to Peak
-60	0.00000100	0.000224	0.000316	0.00063
-59	0.00000126	0.000251	0.000355	0.00071
-58	0.00000158	0.000282	0.000398	0.00080
-57	0.00000200	0.000316	0.000447	0.00089
-56	0.00000251	0.000354	0.000501	0.00100
-55	0.00000316	0.000398	0.000562	0.00112
-54	0.00000398	0.000446	0.000631	0.00126
-53	0.00000501	0.000501	0.000708	0.00142
-52	0.00000631	0.000562	0.000794	0.00159
-51	0.00000794	0.000630	0.000891	0.00178
-50	0.00000100	0.000707	0.001000	0.00200
-49	0.00000126	0.000793	0.001122	0.00224
-48	0.00000158	0.000890	0.001259	0.00252
-47	0.00000200	0.00100	0.001413	0.00283
-46	0.00000251	0.00112	0.001585	0.00317
-45	0.00000316	0.00126	0.001778	0.00356
-44	0.00000398	0.00141	0.001995	0.00399
-43	0.00000501	0.00158	0.002239	0.00448
-42	0.00000631	0.00178	0.002512	0.00502
-41	0.00000794	0.00199	0.002818	0.00564
-40	0.00000100	0.00224	0.003162	0.00632
-39	0.00000126	0.00251	0.003548	0.00710
-38	0.00000158	0.00282	0.003981	0.00796
-37	0.00000200	0.00316	0.004467	0.00893
-36	0.00000251	0.00354	0.005012	0.0100
-35	0.00000316	0.00398	0.005623	0.0112
-34	0.00000398	0.00446	0.006310	0.0126
-33	0.00000501	0.00501	0.007079	0.0142
-32	0.00000631	0.00562	0.007943	0.0159
-31	0.00000794	0.00630	0.008913	0.0178
-30	0.0010	0.00707	0.010000	0.0200
-29	0.0013	0.00793	0.011220	0.0224
-28	0.0016	0.00890	0.012589	0.0252
-27	0.0020	0.00999	0.014125	0.0283
-26	0.0025	0.01121	0.015849	0.0317
-25	0.0032	0.01257	0.017783	0.0356
-24	0.0040	0.01411	0.019953	0.0399
-23	0.0050	0.01583	0.022387	0.0448
-22	0.0063	0.01776	0.025119	0.0502
-21	0.0079	0.01993	0.028184	0.0564
-20	0.0100	0.02236	0.031623	0.0632
-19	0.0126	0.02509	0.035481	0.0710
-18	0.0158	0.02815	0.039811	0.0796
-17	0.0200	0.03159	0.044668	0.0893
-16	0.0251	0.03544	0.050119	0.1002
-15	0.0316	0.03976	0.056234	0.1125
-14	0.0398	0.04462	0.063096	0.1262
-13	0.0501	0.05006	0.070795	0.1416
-12	0.0631	0.05617	0.079433	0.1589
-11	0.0794	0.06302	0.089125	0.1783
-10	0.1000	0.07071	0.100000	0.2000

Power (dBm)	P (mW)	Volts ms into 50 Ω	Volts Peak	Volts Peak to Peak
-9	0.1259	0.07934	0.112	0.2244
-8	0.1585	0.08902	0.126	0.2518
-7	0.1995	0.09988	0.141	0.2825
-6	0.2512	0.11207	0.158	0.3170
-5	0.3162	0.12574	0.178	0.3557
-4	0.3981	0.14109	0.200	0.3991
-3	0.5012	0.15830	0.224	0.4477
-2	0.6310	0.17762	0.251	0.5024
-1	0.7943	0.19929	0.282	0.5637
0	1.0000	0.22361	0.316	0.6325
1	1.259	0.25089	0.355	0.7096
2	1.585	0.28150	0.398	0.7962
3	1.995	0.31585	0.447	0.8934
4	2.512	0.35439	0.501	1.0024
5	3.162	0.39764	0.562	1.1247
6	3.981	0.44615	0.631	1.2619
7	5.012	0.50059	0.708	1.4159
8	6.310	0.56167	0.794	1.5887
9	7.943	0.63021	0.891	1.7825
10	10.000	0.70711	1.000	2.0000
11	12.589	0.79339	1.122	2.2440
12	15.849	0.89019	1.259	2.5179
13	19.953	0.99881	1.413	2.8251
14	25.119	1.12069	1.585	3.1698
15	31.623	1.25743	1.778	3.5566
16	39.811	1.41086	1.995	3.9905
17	50.119	1.58301	2.239	4.4774
18	63.096	1.77617	2.512	5.0238
19	79.433	1.99290	2.818	5.6368
20	100.000	2.23607	3.162	6.3246
21	125.893	2.50891	3.548	7.0963
22	158.489	2.81504	3.981	7.9621
23	199.526	3.15853	4.467	8.9337
24	251.189	3.54393	5.012	10.0237
25	316.228	3.97635	5.623	11.2468
26	398.107	4.46154	6.310	12.6191
27	501.187	5.00593	7.079	14.1589
28	630.957	5.61675	7.943	15.8866
29	794.328	6.30210	8.913	17.8250
30	1000.000	7.07107	10.000	20.0000
31	1258.925	7.93387	11.220	22.4404
32	1584.893	8.90195	12.589	25.1785
33	1995.262	9.98815	14.125	28.2508
34	2511.886	11.20689	15.849	31.6979
35	3162.278	12.57433	17.783	35.5656
36	3981.072	14.10864	19.953	39.9052
37	5011.872	15.83015	22.387	44.7744
38	6309.573	17.76172	25.119	50.2377
39	7943.282	19.92898	28.184	56.3677
40	10000.000	22.36068	31.623	63.2456
41	12589.254	25.08910	35.481	70.9627

• **United States**  
**Anritsu Company**

1155 East Collins Boulevard, Suite 100,  
Richardson, TX, 75081 U.S.A.  
Toll Free: 1-800-267-4878  
Phone: +1-972-644-1777  
Fax: +1-972-671-1877

• **Canada**  
**Anritsu Electronics Ltd.**

700 Silver Seven Road, Suite 120,  
Kanata, Ontario K2V 1C3, Canada  
Phone: +1-613-591-2003  
Fax: +1-613-591-1006

• **Brazil**  
**Anritsu Eletrônica Ltda.**

Praça Amadeu Amaral, 27 - 1 Andar  
01327-010 - Bela Vista - Sao Paulo - SP - Brazil  
Phone: +55-11-3283-2511  
Fax: +55-11-3288-6940

• **Mexico**  
**Anritsu Company, S.A. de C.V.**

Av. Ejército Nacional No. 579 Piso 9, Col. Granada  
11520 México, D.F., México  
Phone: +52-55-1101-2370  
Fax: +52-55-5254-3147

• **United Kingdom**  
**Anritsu EMEA Ltd.**

200 Capability Green, Luton, Bedfordshire LU1 3LU, U.K.  
Phone: +44-1582-433280  
Fax: +44-1582-731303

• **France**  
**Anritsu S.A.**

12 avenue du Québec, Batiment Iris 1-Silic 612,  
91140 Villebon-sur-Yvette, France  
Phone: +33-1-60-92-15-50  
Fax: +33-1-64-46-10-65

• **Germany**  
**Anritsu GmbH**

Nemetschek Haus, Konrad-Zuse-Platz 1  
81829 München, Germany  
Phone: +49-89-442308-0  
Fax: +49-89-442308-55

• **Italy**  
**Anritsu S.r.l.**

Via Elio Vittorini 129, 00144 Roma Italy  
Phone: +39-06-509-9711  
Fax: +39-06-502-2425

• **Sweden**  
**Anritsu AB**

Kistagången 20B, 164 40 KISTA, Sweden  
Phone: +46-8-534-707-00  
Fax: +46-8-534-707-30

• **Finland**  
**Anritsu AB**

Teknobulevardi 3-5, FI-01530 VANTAA, Finland  
Phone: +358-20-741-8100  
Fax: +358-20-741-8111

• **Denmark**  
**Anritsu A/S**

Kay Fiskers Plads 9, 2300 Copenhagen S, Denmark  
Phone: +45-7211-2200  
Fax: +45-7211-2210

• **Russia**  
**Anritsu EMEA Ltd.**  
**Representation Office in Russia**

Tverskaya str. 16/2, bld. 1, 7th floor.  
Moscow, 125009, Russia  
Phone: +7-495-363-1694  
Fax: +7-495-935-8962

• **Spain**  
**Anritsu EMEA Ltd.**  
**Representation Office in Spain**

Edificio Cuzco IV, Po. de la Castellana, 141, Pta. 5  
28046, Madrid, Spain  
Phone: +34-915-726-761  
Fax: +34-915-726-621

• **United Arab Emirates**  
**Anritsu EMEA Ltd.**  
**Dubai Liaison Office**

P O Box 500413 - Dubai Internet City  
Al Thuraya Building, Tower 1, Suite 701, 7th floor  
Dubai, United Arab Emirates  
Phone: +971-4-3670352  
Fax: +971-4-3688460

• **India**  
**Anritsu India Pvt Ltd.**

2nd & 3rd Floor, #837/1, Binnamangla 1st Stage,  
Indiranagar, 100ft Road, Bangalore - 560038, India  
Phone: +91-80-4058-1300  
Fax: +91-80-4058-1301

• **Singapore**  
**Anritsu Pte. Ltd.**

11 Chang Charn Road, #04-01, Shriro House  
Singapore 159640  
Phone: +65-6282-2400  
Fax: +65-6282-2533

• **P. R. China (Shanghai)**  
**Anritsu (China) Co., Ltd.**

27th Floor, Tower A,  
New Caohejing International Business Center  
No. 391 Gui Ping Road Shanghai, Xu Hui Di District,  
Shanghai 200233, P.R. China  
Phone: +86-21-6237-0898  
Fax: +86-21-6237-0899

• **P. R. China (Hong Kong)**  
**Anritsu Company Ltd.**

Unit 1006-7, 10/F., Greenfield Tower, Concordia Plaza,  
No. 1 Science Museum Road, Tsim Sha Tsui East,  
Kowloon, Hong Kong, P. R. China  
Phone: +852-2301-4980  
Fax: +852-2301-3545

• **Japan**  
**Anritsu Corporation**

8-5, Tamura-cho, Atsugi-shi,  
Kanagawa, 243-0016 Japan  
Phone: +81-46-296-6509  
Fax: +81-46-225-8352

• **Korea**  
**Anritsu Corporation, Ltd.**

5FL, 235 Pangyoyeok-ro, Bundang-gu, Seongnam-si,  
Gyeonggi-do, 13494 Korea  
Phone: +82-31-696-7750  
Fax: +82-31-696-7751

• **Australia**  
**Anritsu Pty Ltd.**

Unit 20, 21-35 Ricketts Road,  
Mount Waverley, Victoria 3149, Australia  
Phone: +61-3-9558-8177  
Fax: +61-3-9558-8255

• **Taiwan**  
**Anritsu Company Inc.**

7F, No. 316, Sec. 1, Neihu Rd., Taipei 114, Taiwan  
Phone: +886-2-8751-1816  
Fax: +886-2-8751-1817