

# **SilverLine<sup>®</sup>**

**Test Cables**

**Superior Performance and Durability**



# SilverLine<sup>®</sup> Products at a Glance

## Contents:

Standard SilverLine	4
SilverLine-SF (Super Flex) & SilverLine-LL (Low Loss)	8
SilverLine-TT (Temp Track)	10
SilverLine-XF (Extra Flex)	12
SilverLine-75 (75 Ohm)	14
SilverLine-VNA (26.5 & 40 GHz)	16
SilverLine-VNA (Flex Supreme) (50 & 67 GHz)	20
SilverLine-VNA (110 GHz)	22
Silverline-TG (TuffGrip)	24
SilverLine-DAS (Low PIM)	26
SilverLine-LP (Low PIM)	28
SilverLine-LPA Low PIM Adapters	32
Times Flex Testing Method:	34

## **By Market:**

### **Microwave**

Standard SilverLine, SilverLine-SF (Super Flex), SilverLine-LL (Low Loss), SilverLine-TT (TempTrack), SilverLine-XF (Extra Flex)

### **Millimeter Wave:**

SilverLine-VNA 26.5 & 40 GHz, SilverLine-VNA Flex Supreme 50 & 67 GHz, SilverLine-VNA (110 GHz)

### **Cellular:**

SilverLine-TG (TuffGrip), SilverLine-LP (Low PIM), SilverLine-DAS (Low PIM), Low PIM loads, Low PIM adapters

### **Wireless:**

SilverLine-DAS (Low PIM), Low PIM loads, Low PIM adapters

## **By Application:**

### **OEM/Hi Volume Production Test:**

Standard SilverLine, SilverLine-SF (Super Flex), SilverLine-LL (Low Loss)

### **Research & Development/Metrology:**

Silverline-VNA 26.5 & 40 GHz, Silverline-VNA Flex Supreme 50 & 67 GHz, SilverLine-VNA (110 GHz)

### **RF Laboratory, general use:**

Standard SilverLine, SilverLine-XF

### **Over-Temperature Testing:**

SilverLine-TT, SilverLine-XF

**Cell Site Testing:**

SilverLine-TG (TuffGrip), SilverLine-LP (Low PIM), Low PIM loads, Low PIM adapters

**Distributed Antenna Systems (in-building wireless):**

SilverLine-DAS (Low PIM), Low PIM loads, Low PIM adapters

**By Major Specifications:**

**Maximum Frequency:**

- 3 GHz:** SilverLine-LP (Low PIM), SilverLine-DAS (Low PIM), Low PIM Loads, Low PIM adapters
- 4 GHz:** Standard SilverLine, SilverLine-SF (Super Flex), SilverLine-LL (low Loss), SilverLine-TT (Temp Track) only with BNC connector option
- 6 GHz:** Standard SilverLine, SilverLine-SF (Super Flex), SilverLine-LL (Low Loss), SilverLine-TT (Temp Track), Silver-Line-XF (Extra Flex), all with 6 GHz cable option
- 18 GHz:** Standard SilverLine, SilverLine-SF (Super Flex), SilverLine-LL (Low Loss), SilverLine-TT (Temp Track), SilverLine-TG, Silver-Line-XF (Extra Flex), all with 18 GHz cable option
- 26.5 GHz:** Standard SilverLine, SilverLine-VNA
- 40 GHz:** SilverLine-VNA
- 50 & 67 GHz:** SilverLine-VNA Flex Supreme
- 110 GHz:** SilverLine-VNA 110 GHz

**Attenuation/Core Construction:**

	Frequency (GHz), db/ft									
	3	6	12	18	26.5	40	50	67	110	
SilverLine-XF (Extra Flex):	0.30	0.43	0.64	0.81	n/a	n/a	n/a	n/a	n/a	Solid TF-4
SilverLine, SilverLine-SF, SilverLine-TT:	0.19	0.34	0.53	0.68	0.89	n/a	n/a	n/a	n/a	Solid PTFE (TempTrack is TF-4)
SilverLine-LL (low loss):	0.17	0.26	0.37	0.46	n/a	n/a	n/a	n/a	n/a	Tape wrapped PTFE
SilverLine-VNA:	0.19	0.28	0.41	0.52	0.64	0.83	n/a	n/a	n/a	Foam PTFE
SilverLine-VNA Flex Supreme:	n/a	n/a	n/a	n/a	n/a	n/a	1.04	1.98	n/a	Micro-porous PTFE
SilverLine 110 GHz:	n/a	n/a	n/a	n/a	n/a	n/a	n/a	n/a	5.00	Micro-porous PTFE
SilverLine-DAS (Low PIM):	0.11	n/a	n/a	n/a	n/a	n/a	n/a	n/a	n/a	Tape wrapped PTFE or Foam PE
SilverLine-LP (Low PIM):	0.08	n/a	n/a	n/a	n/a	n/a	n/a	n/a	n/a	Tape wrapped PTFE or Foam PE

**Cable Diameter (nom): (diameter generally influences flexibility and bend radius)**

- 0.155" SilverLine-XF (Extra Flex)
- 0.185" SilverLine-VNA 110 GHz
- 0.195" Standard SilverLine, SilverLine-TT (Temp Track), SilverLine-75
- 0.200" SilverLine-LL (Low Loss), SilverLine-SF (Super Flex)
- 0.308" SilverLine-VNA Flex Supreme
- 0.430" SilverLine-VNA, SilverLine-TG
- 0.450" Standard SilverLine, SilverLine-SF, SilverLine-LL (low Loss), and SilverLine-TT (Temp Track) with PVC or steel armor options
- 0.480" SilverLine-DAS (Low PIM)
- 0.590" SilverLine-LP (Low PIM)

**By approximate starting price:(1 piece, typical length and connector configuration)**

SilverLine-XF:	\$98.00
SilverLine, SilverLine-SF, SilverLine-LL, SilverLine-TT:	\$150.00
SilverLine-TG	\$375.00
SilverLine-DAS:	\$235.00
SilverLine-LP:	\$429.00
SilverLine-VNA:	\$615.00
SilverLine-VNA Flex Supreme	\$1550.00
SilverLine-VNA 110 GHz:	\$3550.00
SilverLine-LPA (low PIM adapters):	\$30.00
Low PIM Loads:	\$660.00

# SilverLine®

## Test Cables

ISO 9001 Certified

### Coax Test Cables for:

- High Volume Production Test Stations
- Research & Development Labs
- Environmental & Temperature Test Chambers
- Replacement for OEM Test Port Cables
- Field RF Testing
- Cellular Infrastructure Site Testing



SilverLine® Test Cables are cost effective, durable, high-performance cable assemblies designed for use in a broad range of test and interconnect applications. Fabricated from rugged, solid PTFE dielectric cable with stainless steel connectors and a proven strain relief system, these cables provide long life and excellent stability in applications where they are repeatedly flexed and mated/unmated. SilverLine® test cables are ideal for use in production, field and laboratory test environments. They are also economical enough to be used as interconnects in test systems.

### Features & Benefits:

- Phase & Loss Stable
- Long Flex Life
- Triple Shielded Cable
- High Mating Cycle, Stainless Steel Connectors
- Rugged, Solder-Clamp Attachment
- Redundant, Long Life Strain Relief System
- ROHS Compliant

### Time's Silverline® Product Guarantee

Times will repair or replace your SilverLine test cable at its option if the connector attachment fails within four months of shipment. This guarantee excludes cable or connector interface damage from misuse or abuse.

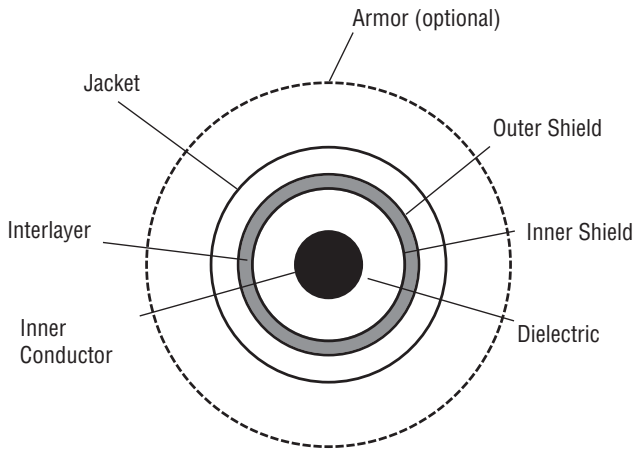

### Cable Construction

**Inner Conductor:** Solid silver plated copper clad steel

**Dielectric:** Solid PTFE

**Shield:** Silver plated copper flat ribbon braid aluminum-polyimide tape interlayer 36 GA silver plated copper braid (90%k)

**Jacket:** Clear FEP

**Armor (Optional):**

**PVC Style:** Steel wire reinforced, thick wall, high flex life clear PVC

**Steel Style:** 100% coverage, square locked, galvanized steel hose, high angle steel braid and TPR jacket

### Connectors

- Passivated stainless steel finish (QMA coupling nut is nickel plated brass)
- QMA SureGrip™ coupling nut design
- Captive contact
- Thick wall interface (SMA)
- Gold plated beryllium copper center contacts
- PTFE dielectric
- Type N & SMA OneTurn™ (1 full rotation to mate)
- High temperature 7mm
- Knurl/hex coupling nut (Type N and TNC)
- Precision grade 7-16

### Connector Attachment/Strain Relief

- Rugged, solder-clamp to braid. 175-300 lb pull force. Additional crimp system on armored version.
- Redundant triple layer strain relief system (Dual layer on armored version)

## Physical & Mechanical Specifications

Dimensions	in	mm
Inner Conductor	0.037	0.94
Dielectric	0.116	2.95
Inner Shield	0.126	3.20
Interlayer	0.132	3.35
Outer Shield	0.154	3.91
Jacket	0.195	4.95
Armor (optional)	0.450	11.50
Weight lbs./ft (kg/m)	Cable: 0.043 (0.064)	Armor: 0.066 (0.098)
Armor Crush Resistance	PVC:1200 lbs. per linear inch - Steel:1500 lbs. per linear inch	
Bend Radius: Minimum	1	25
Connector Retention	Unarmored & Armored PVC > 175lbs-Steel Armored > 300 lbs	
Mating Life Cycle	QMA, SMA, Type N: > 5000*	
Length Tolerances	$\leq 2$ ft. or 0.75m, -0, +0.50" (12.7m) $> 2$ ft. or 0.75m, -0, +2% of length	
Temperature Range	-67° / +221° F	-55° / +105° C

## Electrical Specifications

VSWR Max		4 GHz	6 GHz	18 GHz	26.5 GHz
	BNC	1.20:1			
7-16 DIN			1.25:1		
SMA,QMA, 3.5mm			1.20:1	1.30:1	1.35:1
Type N, TNC, Swept R/A			1.30:1(cube R/A)	1.35:1(cube R/A)	
7mm			1.25:1	1.35:1	

Impedance	50 Ohms
Velocity of Propagation	70%
Shielding Effectiveness	>100dB
Capacitance	29.4 pf/ft = 96.4 pf/meter
Phase Stability (50,000 cycles)***	+/-2° through 18 GHz +/-3° through 26.5 GHz

### Attenuation Max @ +77° F (+25°C)

Attenuation (GHz)	dB/100 ft	dB/100 m
1	12	40
2	18	59
6	34	112
12	53	174
18	68	224
26.5	89	290

Attenuation at any frequency formula:	$(K1 * \sqrt{F}(\text{MHz})) + (K2 * F(\text{MHz}))$
K1	0.348
K2	0.0012

### Power Handling @ +77°F (+25°C) (Sea Level) (Cable Only)\*\*

Power Handling (GHz)	Watt (max.)
0.4	891
1	539
2	363
6	180
12	117
18	88
26.5	65

\* SMA Male & Type N: Assumes use of calibrated torque wrench, proper care and cleaning of interface and mated connector is within mil spec limits. QMA: Assumes proper use, care and cleaning.

\*\* Connector configuration may limit cable assembly maximum power handling capability.

\*\*\*See SilverLine-VNA data sheet for flex test conditions.

\*Specifications subject to change without notice

# SilverLine® Test Cables

(26.5 GHz SMA Male/SMA Male, 3 ft long)

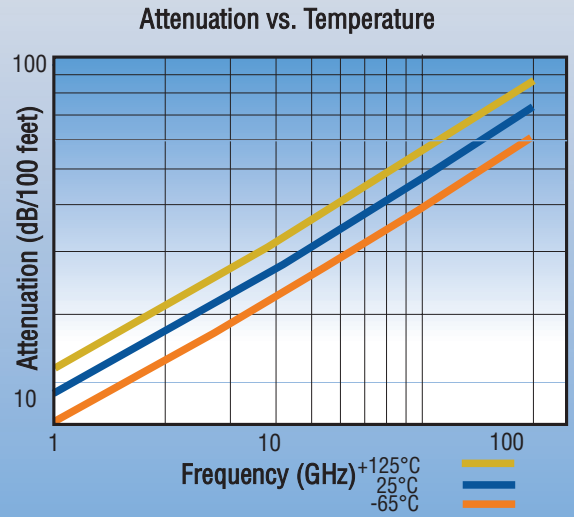
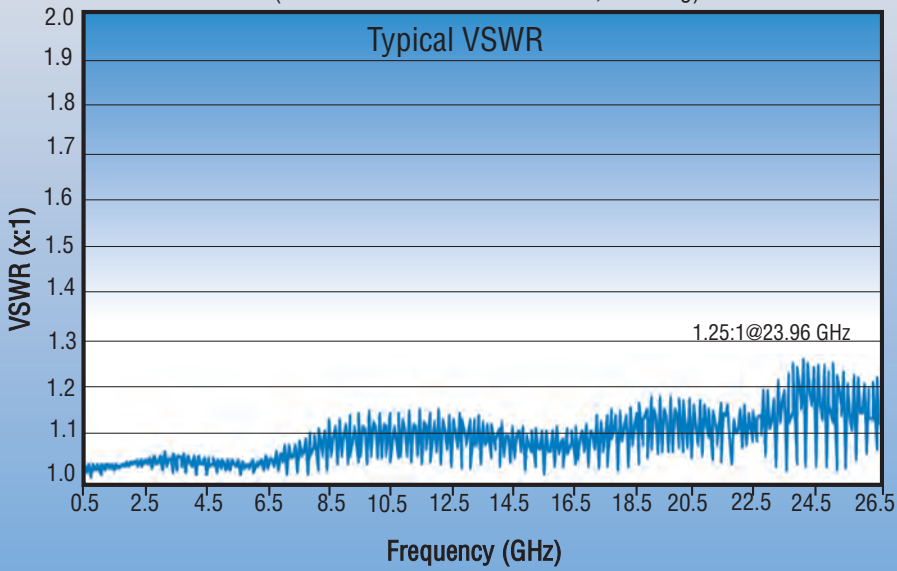

## Ordering Information

- U = Unarmored 1ft (0.25m) minimum assembly length
- A = Armored 2 ft (0.5m) minimum assembly length
- S = Steel, torque & crush resistant armor 3 ft (1.0m) min. length

SW suffix: Swept Right Angle - unarmored only

**Feet:** 0.50 ft increments  
Example: -04.50F = 4.50 ft

**Meters:** 0.25 m increments  
Example: -00.75M = 0.75 m

**SLXXX-XXXXXXXXXX-XX.XXX**

F= Feet M = Meters

### Maximum Frequency

- 04 = 4.0 GHz (BNC one or both ends)
- 06 = 6.0 GHz
- 18 = 18.0 GHz
- 26 = 26.5 GHz



3.5mm Female (L)  
Ruggedized 3.5mm Female (R)



Times QMA SureGrip™

### Connector Codes (2 or 3 Characters)

- BM = BNC Male
- SM = SMA Male
- S1T = SMA Male OneTurn™
- SF = SMA Female
- SMR = SMA Right Angle
- 35M = 3.5mm Male
- 35F = 3.5mm Female
- 3RF = 3.5mm Ruggedized Female
- NM = Type N Male
- N1T = Type N Male OneTurn™
- NF = Type N Female
- NMR = Type N Right Angle
- 70M = 7mm
- 76F = 7-16 Female
- TM = ETNC Male (Extended range)
- TF = ETNC Female (Extended range)
- QMM = QMA Male

First Connector

Second Connector

A brand new cable can have a break-in period of several hundred flexes.

Labels on unarmored assemblies under 1.5 feet (0.5m) long remain loose to increase flexibility.  
Some connector combinations and / or lengths may be unavailable.  
Please contact Times or your Times authorized representative.

Now there is a SilverLine® Test Cable available for almost every application:

- SilverLine® for high volume production RF testing
- SilverLine®- TG (TuffGrip) for cell site distance to fault testing
- SilverLine®- LP (Low PIM) for cell site Passive Intermodulation testing
- SilverLine®- VNA for 26.5, 40, 50, 67 and 110 GHz R&D testing
- SilverLine®- SF (Super Flex) for more flexibility
- SilverLine®- XF (Extra Flex) for tight areas and breadboard development
- SilverLine®- LL (Low Loss) 30% lower loss
- SilverLine®- DAS (Distributed Antenna System) for in-building wireless radio testing
- SilverLine®-75 for 75 Ohm OEM replacement test port cables
- SilverLine®-TT for phase critical RF/microwave measurements
- SilverLine®-LPA Low PIM adapters

Visit our website or contact your Times local representative for more information.

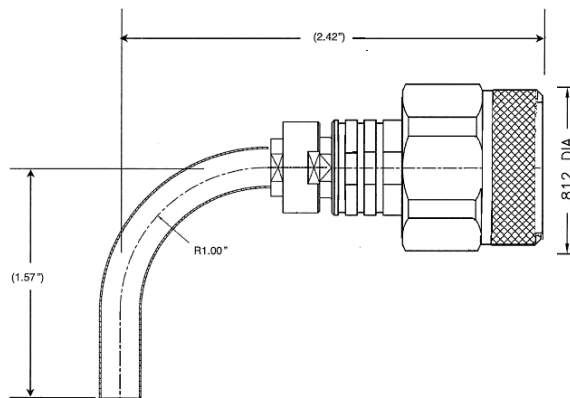

Swept r/a Type N

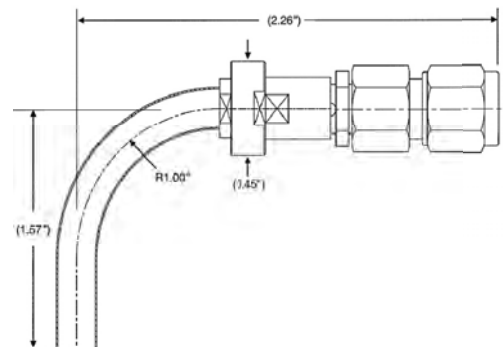

Swept r/a SMA

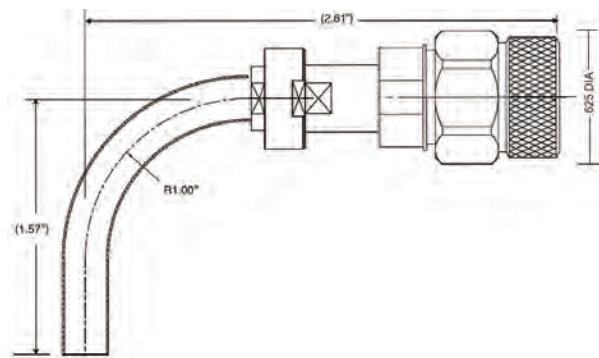

Swept r/a TNC

# SilverLine<sup>®</sup>-SF (Super Flex) & SilverLine<sup>®</sup>-LL (Low Loss)

ISO 9001 Certified

## Coaxial Test Cables For:

- High volume production test stations
- Research and development labs
- Replacement for OEM test cables



### SilverLine<sup>®</sup>-SF (Super Flex)

SilverLine<sup>®</sup>-SF is approximately 40% more flexible than traditional SilverLine<sup>®</sup>. This is accomplished by replacing the steel center conductor with copper and the FEP outer jacket with polyurethane. SilverLine<sup>®</sup>-SF retains its bent shape. That is, the cable has memory.

### SilverLine<sup>®</sup>-LL (Low Loss)

SilverLine<sup>®</sup>-LL is a low loss version of traditional SilverLine. Along with the SF changes above the solid core is replaced with tape wrapped PTFE. Flexibility is similarly increased, memory is introduced and the attenuation is reduced by approximately 30%.

Both SilverLine<sup>®</sup>-SF and SilverLine<sup>®</sup>-LL use the robust, proven connector attachment and strain relief systems that have become so popular and successful with original SilverLine<sup>®</sup>.

#### Time's Silverline<sup>®</sup> Product Guarantee

Times will repair or replace your SilverLine test cable at its option if the connector attachment fails within four months of shipment. This guarantee excludes cable or connector interface damage from misuse or abuse.

### Features & Benefits

- 40% More Flexible
- 30% Lower Loss (SilverLine<sup>®</sup>-LL Only)
- Identical Proven Attachment Method
- ROHS Compliant



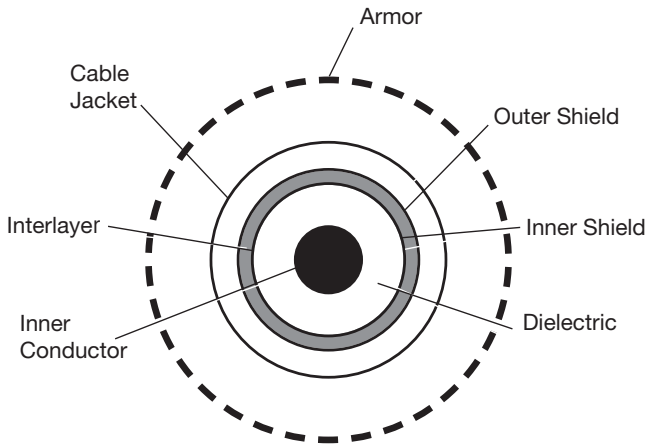

### Cable Construction

**Inner Conductor:** Solid silver plated copper

**Dielectric:** SilverLine-SF® (Super Flex); solid PTFE SilverLine-LL® (Low Loss); expanded tape wrapped PTFE

**Shield:** Silver-plated copper flat ribbon braid aluminum-polyimide tape interlayer 36 GA silver-plated copper round braid (90%k)

**Jacket:** Clear polyurethane

**Armor:** Optional

**PVC Style:** Steel reinforced, thick wall high flex life clear PVC

**Steel Style:** 100% coverage, square locked, galvanized steel hose, high angle steel braid and TPR jacket

**Connectors:** Captive contact, stainless steel construction

\*SMA and Type N only. Mating life assumes the use of a calibrated torque wrench, interfaces are clean and within mil spec limits.

\*\*See SilverLine-VNA data sheet for flex test conditions. A brand new cable can have a break-in period of several hundred flexes.

Specifications subject to change without notice

Mechanical Specifications				
Dimensions		in	mm	
Outside Diameter		0.195	4.95	
Armor (optional)		0.450	11.50	
Minimum Bend Radius		1	25	
Connector Retention		>125 lbs		
Crush Resistance (armored)		1200 lbs per linear inch		
Mating Life Cycle		>5000*		
Temperature Range		-67° / +185°F	-55° / +85°C	
Electrical Specifications				
VSWR Max		4 Ghz	6 Ghz	18 Ghz
	BNC	1.2:1		
	QMA, SMA, Type N, TNC, Swept r/a		1.25:1	1.30:1
	SMA r/a, N r/a, 7mm		1.25:1	1.35:1
Impedance	50 Ohms			
Velocity of Propagation	Super Flex: 70% <b>Low Loss: 76%</b>			
Shielding Effectiveness	>100 dB			
Capacitance	SF: 29.4 pf (96.4 pf/m) <b>LL: 26.7 pf/ft (87.6 pf/m)</b>			
Phase Stability (25,000 cycles)**	+/-5° through 18 GHz			
Attenuation, max @77°F (25°C)	Super Flex <b>Low Loss</b>			
	Frequency (Ghz)	dB/100 ft (dB/100 m)		<b>dB/100 ft (dB/100 m)</b>
	1	12 (40)	<b>10</b>	<b>(33)</b>
	2	18 (59)	<b>15</b>	<b>(49)</b>
	6	34 (112)	<b>26</b>	<b>(85)</b>
	12	52 (174)	<b>37</b>	<b>(121)</b>
	18	68 (224)	<b>46</b>	<b>(150)</b>
Cable Power Handling @77°F (25°C) sea level, watts, (max)				
	Frequency Ghz	Super Flex		<b>Low Loss</b>
	1	539		<b>340</b>
	2	363		<b>240</b>
	6	180		<b>130</b>
	12	117		<b>90</b>
	18	88		<b>70</b>

## Ordering Information

U = unarmored  
A = PVC armor  
S = Steel armor

**Cable Type**  
SF = Super Flex  
**LL = Low Loss**

**Maximum Frequency**  
04 = 4 Ghz (BNC Only)  
06 = 6 Ghz  
18 = 18 Ghz

SW suffix: Swept Right Angle unarmored only

**SLXXXXX-XXXXXXXXXX-XX.XXX**

Feet 0.5 ft increments  
Meters 0.25m increments

F=Feet, M=Meters

**Connector Codes 2 or 3 Characters**

SM = SMA male  
SF = SMA female  
S1T = SMA male oneTurn™  
SMR = SMA right angle  
NM = Type N male  
N1T = Type N OneTurn™  
NF = Type N female  
NMR = Type N right angle  
70M = 7mm  
TM = TNC male  
TF = TNC female  
QMM = QMA male

First Connector

↓

Second Connector

A brand new cable can have a break-in period of several hundred flexes.

# SilverLine<sup>®</sup>-TT (TempTrack)

ISO 9001 Certified

## Coaxial Test Cables For:

- *RF Testing From 0° C to +30° C*
- *Phase Critical RF/Microwave Measurement*
- *Research and Development*

Now +125°C  
Operating Temperature  
on Both Armored and  
Unarmored Style!\*



SilverLine<sup>®</sup>-TT features solid TF-4<sup>™</sup> dielectric. This proprietary dielectric exhibits smaller and more linear phase change at normal ambient temperatures of 0° C to + 30° C, when compared to solid PTFE. Although somewhat improved phase performance can be achieved using foam, taped or spline dielectrics, ruggedness is sacrificed and the phase performance achieved is not as good as the SilverLine<sup>®</sup>-TT. The graph below compares solid PTFE to solid TF-4<sup>™</sup>.

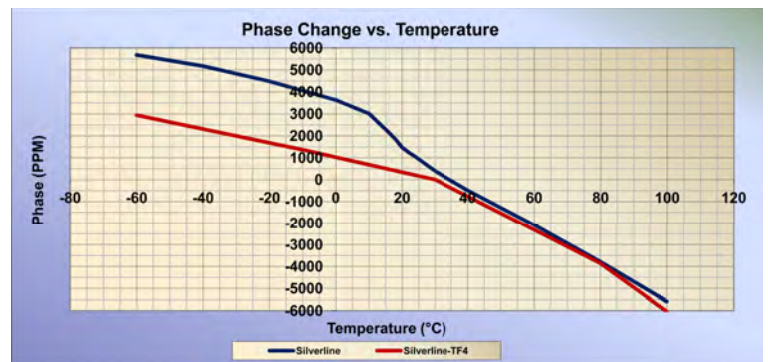

## Time's *Silverline*<sup>®</sup> Product Guarantee

Times will repair or replace your SilverLine test cable at its option if the connector attachment fails within four months of shipment. This guarantee excludes cable or connector interface damage from misuse or abuse.

## Features & Benefits

- *Less and Linear Phase Change From 0° C to + 30° C*
- *Stainless Steel Connectors*
- *Ruggedized Cable/Connector Interface*
- *ROHS Compliant*

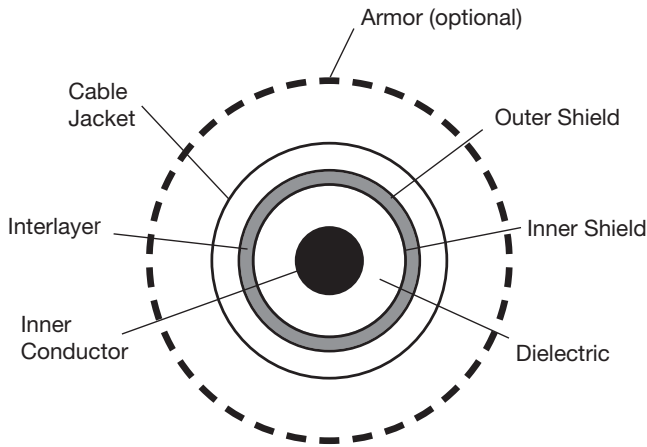

**Cable Construction**

**Inner Conductor:** Solid silver plated copper

**Dielectric:** Solid TF-4™

**Shield:** Silver-plated copper flat ribbon braid aluminum-polyimide tape interlayer 36 GA silver-plated copper round braid (90%k)

**Jacket:** Clear FEP

**Armor:** Optional

**Steel Style:** 100% coverage, square locked, galvanized steel hose, high angle steel braid and high temp TPR jacket

**Connectors**

- Stainless steel construction
- SMA and Type N OneTurn™ options

\* SMA and Type N mating life assumes the use of a calibrated torque wrench, interfaces are clean and within mil spec limits.

\*\*See SilverLine-VNA data sheet for flex test conditions. A brand new cable can have a break-in period of several hundred flexes.

Specifications subject to change without notice.

Mechanical Specifications			
Dimensions		in	mm
Outside Diameter		0.195	4.95
Armor (optional)		0.450	11.50
Minimum Bend Radius (unarmored)		1	25
Connector Retention		>175 lbs (unarmored) 300 lbs (armored)	
Crush Resistance (armored)		1500 lbs per linear inch	
Mating Life Cycle		>5000*	
Increased Temperature: *(Serial# 32,000 & above)		Unarmored: - 67° / + 257° F (- 55° / +125° C) Armored: - 67° / + 257° F (- 55° / +125° C)	
<b>VSWR Max</b>			
		6 Ghz	18 Ghz
	SMA, Type N, TNC, Swept r/a	1.25:1	1.30:1
	SMA r/a, Type N, r/a	1.30:1	1.35:1
Impedance		50 Ohms	
Velocity of Propagation		70%	
Shielding Effectiveness		>100 dB	
Capacitance		29.0 pf/ft (95.1 pf/m)	
Phase Stability ** (50,000 cycles)		+/-2° through 18 GHz	
Phase change from 0° to + 30° C		35 ppm/deg C +/-10 ppm/deg C	
Attenuation, max @77°F (25°C)			
	Frequency (Ghz)	dB/100 ft	(dB/100 m)
	1	12	(40)
	2	18	(59)
	6	35	(115)
	12	53	(174)
	18	69	(226)
<b>Cable Power Handling @77°F (25°C) sea level, watts, (max)</b>			
	Frequency Ghz		
	1		444
	2		304
	6		163
	12		108
	18		86

Ordering Information

U = unarmored  
SB = steel armor

Cable Type  
TT = Temp Track

Maximum Frequency  
06 = 6 Ghz  
18 = 18 Ghz

SW suffix: Swept Right Angle  
unarmored only

**SLXXTTXX-XXXXXXXXXX-XX.XXX**

Feet 0.5 ft increments  
Meters 0.25m increments

F = Feet, M = Meters

Connector Codes 2 or 3 Characters

SM = SMA male  
SF = SMA female  
SMR = SMA right angle  
NM = Type N male  
NF = Type N female  
NMR = Type N right angle  
TM = TNC male  
TF = TNC female

First Connector

↓

Second Connector

A brand new cable can have a break-in period of several hundred flexes.

# SilverLine<sup>®</sup>-XF (Extra Flex)

ISO 9001 Certified

## Coaxial Test Cables

- 36% Smaller Diameter
- Improved Flexibility
- RF Stable With Flexure
- Triple Shielded, 18 GHz Operation
- **Linear Phase Change From 0° to 30°C**
- Injection-Molded Strain Relief

Now Available  
in a  
High Temperature  
Version!

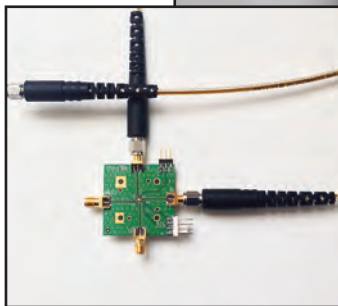
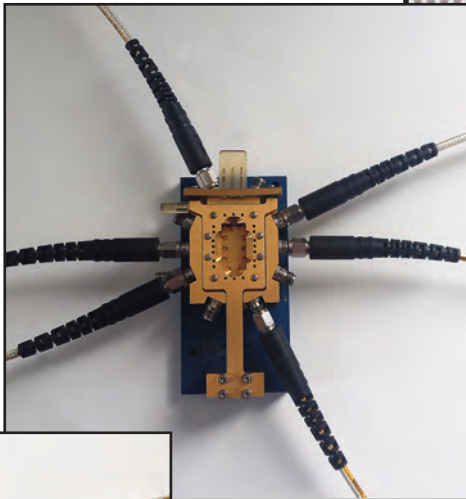

Test fixture photo courtesy of  
Inter-Continental Microwave  
[www.icmicrowave.com](http://www.icmicrowave.com)

SilverLine<sup>®</sup>-XF was designed for testing delicate components such as exposed RF circuits with edge launch connectors. Thin, lightweight and flexible this coax makes handling PC boards easy yet does not compromise RF stability and isolation. **Using Times' proprietary TF-4 dielectric SilverLine<sup>®</sup>-XF goes one step further, exhibiting linear phase change from 0°C to +30°C (see graph).**

SilverLine<sup>®</sup>-XF uses the same robust, proven connector attachment system that has made SilverLine<sup>®</sup> the preferred choice in RF test labs everywhere. A new injection-molded strain relief system designed to match the cable's flexibility assures the cable will bend tightly but not fail prematurely behind the connector.

- Popular Lengths & Configurations in Stock  
(Contact Times Microwave for more information).

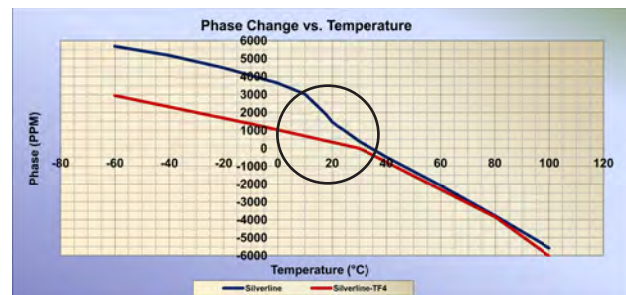

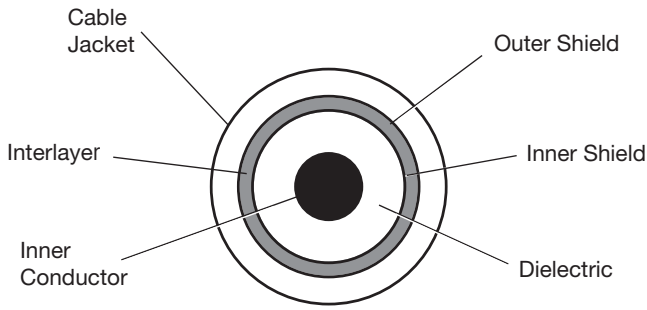

### Cable Construction

**Inner Conductor:** Solid silver-plated copper clad steel

**Dielectric:** Solid TF-4

**Shield:** Silver-plated copper flat ribbon braid, aluminum-polyimide tape interlayer, silver-plated copper round wire braid, (90%k)

**Jacket:** Clear polyurethane (HT version = FEP)

### Connectors:

- Stainless steel
- Solder/Clamp attachment
- Captive contact construction

\* Mating life assumes the use of a calibrated torque wrench, interfaces are clean and within mil specs limits.

Specifications subject to change without notice.

Mechanical Specifications		
Dimensions	in	mm
Outside Diameter	0.150	3.80
Minimum Bend Radius	0.75	19
Mating Life Cycle	>5000*	
Temperature Range	-55/+85°C (HT version = +125°C)	
Electrical Specifications		
VSWR through 18 GHz	1.30:1 typ, 1.35:1 max	
Impedance	50 Ohms	
Velocity of Propagation	70%	
Shielding Effectiveness	>100 dB	
Capacitance	28.8 pf/ft (94.4 pf/m)	
Phase Stability (typ) ** (75,000 cycles)	+/-3° @ 18 GHz	
Attenuation, max @77°F (25°C)		
	Frequency (GHz)	dB/100 ft (dB/100 m)
	1	16 (52)
	2	24 (79)
	6	43 (141)
	12	64 (210)
	18	81 (257)
Attenuation at any frequency formula: $0.49656 \cdot \sqrt{f} + 0.0007989 \cdot f$ (f=freq in MHz)		



\*\* Phase stability data IAW Times' phase/flex test criteria as demonstrated above.

## Ordering Information

**SilverLine**  
**Unarmored**  
**EXtraFlex**

Omit for polyurethane jacket version  
HT = FEP high temperature version

**SLUXFXX18-XXXX-XX.XXX**

Feet 0.5 ft increments  
Meters 0.25m increments

F=Feet, M=Meters

06 = 6 GHz  
18 = 18 GHz

**Connector Codes, 2 Characters**  
SM = SMA male  
S1T= SMA OneTurn™ (selected assemblies)  
NM = Type N male

First Connector  
↓  
Second Connector

A brand new cable can have a break-in period of several hundred flexes.

# SilverLine<sup>®</sup>-75 (75 Ohm)

## Coaxial Test Cables

ISO 9001 Certified

- 75 Ohm OEM replacement test port cables
- CATV, Broadband
- Subscriber drop products, 75 Ohm coax cable & connector manufacturing



SilverLine<sup>®</sup>-75 (75 Ohm) exhibits identical RF performance to major test equipment maker's OEM cables yet with vastly increased durability and ruggedness. That's because SilverLine<sup>®</sup>-75 uses the same robust, proven connector attachment and strain relief systems that have made our 50 Ohm version the first choice of demanding customers around the world.

Times uses only the highest quality, highest performing connector and cable designs in all SilverLine<sup>®</sup> products. SilverLine<sup>®</sup>-75 follows the same tradition.

### Features & Benefits:

- Replaces Agilent 11857 series and similar 75 Ohm test port cables.
- Use with Agilent, Rohde & Schwarz or other 75 Ohm network analyzers
- Precision stainless steel 75 Ohm Type N & F connectors
- Exceptional return loss
- Proven connector attachment method
- ROHS Compliant

#### Time's Silverline<sup>®</sup> Product Guarantee

*Times will repair or replace your SilverLine test cable at its option if the connector attachment fails within four months of shipment. This guarantee excludes cable or connector interface damage from misuse or abuse.*

R&S ZVL3-75: 75 Ω Vector Network Analyzer  
Reproduced with Permission, Courtesy of Rohde & Schwarz  
Agilent E5061B ENA Series Network Analyzer  
Copyright Agilent Technologies, Inc. 07/31/13  
Reproduced with Permission, Courtesy of Agilent Technologies, Inc.

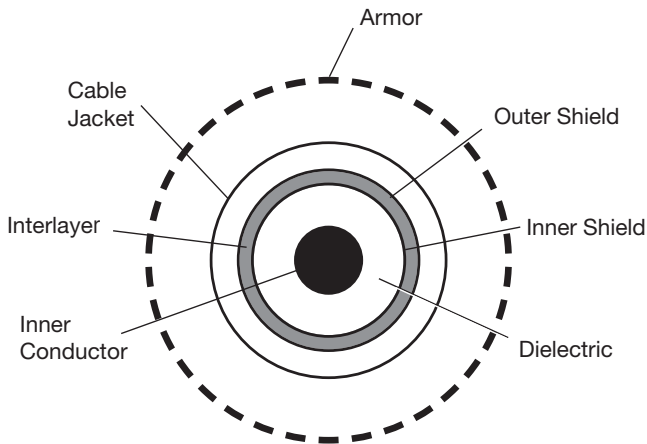

### Cable Construction

**Inner Conductor:** Solid silver plated copper clad steel

**Dielectric:** Solid PTFE

**Shield:** Silver-Plated Copper flat ribbon braid aluminum-polyimide tape interlayer 36 GA silver-plated copper round braid (90%k)

**Jacket:** Clear FEP

**Armor:** PVC and steel options

**PVC:** Steel reinforced, thick wall high flex life clear PVC

**TPR-Steel:** 100% coverage, square locked, galvanized steel hose, high angle steel braid and TPR jacket

**Connectors:** Captive contact, stainless steel construction

\*Mating life assumes the use of a calibrated torque wrench, interfaces are clean and within mil spec limits.

Mechanical Specifications			
Dimensions		in	mm
Outside Diameter		0.195	4.95
Armor (optional)		0.450	11.50
Minimum Bend Radius		1	25
Connector Retention		>175 lbs (unarmored) 300 lbs (armored)	
Crush Resistance (armored)		PVC: 1200 lbs./linear in. Steel: 1500 lbs./linear in	
Mating Life Cycle		>5000*	
Temperature Range		-67°/+ 257°F	-55° / +125°C
Electrical Specifications			
VSWR		1 Ghz	3 Ghz
Max	F Type and Type N	1.11:1 (26 dB RL)	1.13:1 (24 dB RL)
Impedance		75 Ohms	
Velocity of Propagation		70%	
Shielding Effectiveness		>100 dB	
Capacitance		19.2 pf/ft (63pf/m)	
Attenuation, max @77°F (25°C)			
	Frequency (Ghz)	dB/100ft	(dB/100 m)
	0.5	8.4	(27.6)
	1	12.2	(39.4)
	2	17.9	(58.7)
	3	22.7	(74.5)
Cable Power Handling @77°F (25°C) sea level, watts, (max)			
	Frequency Ghz		
	0.5	400	
	1	280	
	2	190	
	3	150	

\*Specifications subject to change without notice

### Ordering Information

U = unarmored  
A = PVC armor  
S = Steel armor

Feet 0.5 ft increments  
Meters 0.25m increments

SLX75-XXXXXX-XX.XXX

75 Ohm

F=Feet, M=Meters

Connector Codes 2 or 3 Characters

FM = F type male  
FF = F type female  
NM7 = Type N male  
NF7 = Type N female

A brand new cable can have a break-in period of several hundred flexes.

# SilverLine<sup>®</sup>-VNA (26.5 and 40 GHz)

ISO 9001 Certified

## Vector Network Analyzer Test Cables

- Vector Network Analyzer Measurements
- Laboratory Use



SilverLine<sup>®</sup>-VNA is a precision test cable with excellent loss, VSWR and phase/flexure stability. Protected by a torque and crush resistant armor, SilverLine<sup>®</sup>-VNA test cables exhibit extraordinary ruggedness comparable to OEM supplied test cables but at a fraction of the cost, making them the ideal choice for daily use in factory and lab applications.

The braided PET outer jacket makes SilverLine<sup>®</sup>-VNA easy to handle, non-conductive and improves flexibility when compared to extruded jackets. The chrome plated metal back shell maintains the integrity of the cable to connector interface and allows for easy handling.

### Features & Benefits:

- 26.5 and 40 GHz options
- Low loss 40 GHz cables now available!
- Phase, Loss & VSWR stable
- High flex life
- Torque and crush resistant stainless steel armor
- Chrome plated strain relief back shells
- ROHS Compliant



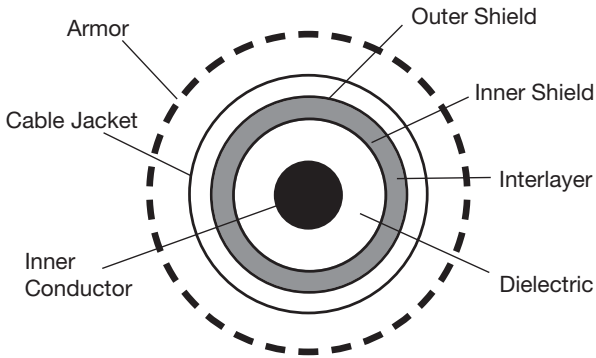

**Cable Construction**

**Inner Conductor:**

Solid silver plated copper

**Dielectric:**

Micro-porous PTFE

**Shield:**

Metalized tape interlayer and silver plated copper round braids

**Jacket: FEP**

**Armor:**

100% coverage, non-interleaved, stainless steel spiral sheath for crush resistance and captured, opposing force steel braid for torque resistance. PET monofilament yarn outer cover to eliminate conductivity and improve handling

**Connectors:**

- Instrument grade
- Passivated stainless steel
- Captive center contacts

**Attachment Method:**

Solder/clamp/crimp. Protective metal back shell

**Physical & Mechanical Specifications**

Dimensions	in	mm
Outside Diameter Over Armor	0.43	10.8
Armor Crush Resistance	1050 lbs per linear inch	
Bend Radius (min)	2.5"	
Connector Retention	150 lbs	
Connector Mating Life (min)*	500*	

**Electrical Specifications**

VSWR Max.	26.5 GHz	40 GHz
3.5mm	1.35:1	
2.9 mm & 2.4 mm	1.45:1	
Impedance	50 ohms	
Velocity of Propagation	78% nominal	
Shielding Effectiveness	> 100 db	
Capacitance	26 pf/ft	
Phase Stability**	+/- 5° typical, +/- 10° max	
Amplitude Stability (max)**	+/- 0.25 db	
Return Loss Stability**	better than 1.5 db	
Flex Life**	10,000 min, 25,000 typical	
Attenuation, max @ 77° (25° C)		

Frequency (GHz)	dB/100 ft	(dB/100 m)
1	11	(36)
6	28	(92)
12	41	(135)
18	51	(167)
26	63	(206)
40	82	(269)

Max Power Handling @ 77° F (25° C), sea level, (cable only)	
Frequency (Ghz)	Watts
1	1190
6	460
12	310
18	240
26	200
40	150

Serialized, plotted loss and VSWR data supplied with every cable

\*Specifications subject to change without notice.

\*Requires mating connections to be clean and within mechanical specifications. Calibrated torque wrench required.

\*\*RF stability and flex life are in accordance with the flex test method example on P.3. Data is for cables 4ft or shorter. Longer cables may exhibit different stability characteristics. A cable will exhibit some instability when new. A very brief period of use is required to alleviate cable component stresses from manufacturing after which the cable will "settle" and maintain the values stated.

## Flex Test

40 GHz Flex Test (one full cycle)

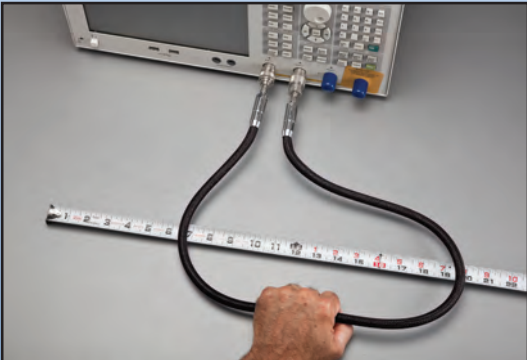
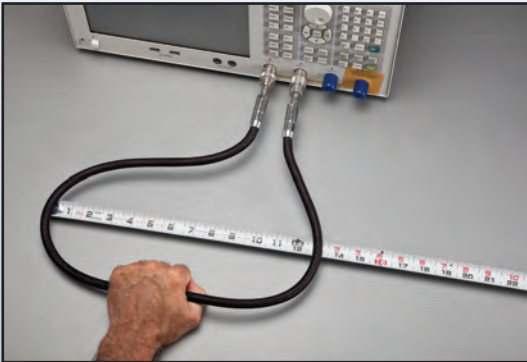

Cable is pulled off center 10" in both directions

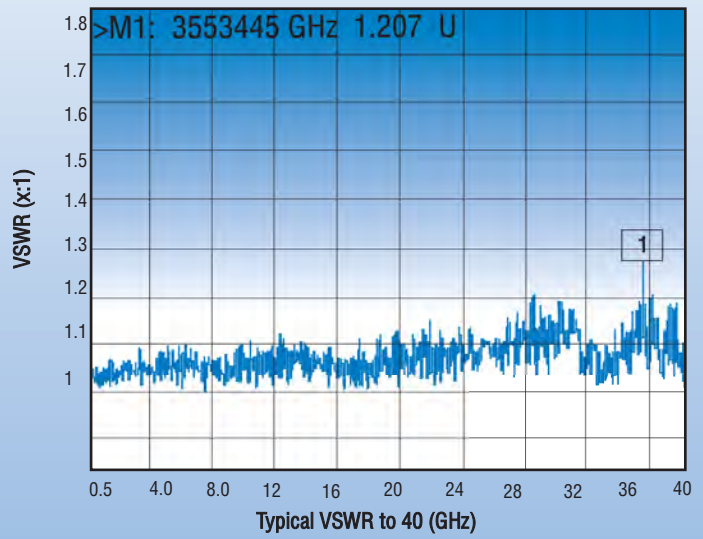

## Ordering Information

SilverLine, Steel Armor, VNA Style

Feet: 0.5ft increments  
 Meters: 0.25m increments  
 Min length: 1.5ft (0.5 meters)

\*Lengths longer than 6ft (2m) will have an extruded TPR outer jacket replacing the PET weave for improved durability.

SLSVXX-XXXXXX-XX.XXX

F = Feet, M = Meters

Maximum Frequency

26 = 26.5 GHz  
 40 = 40 GHz

- 35M = 3.5mm male (26.5 GHz)
- 35F = 3.5mm female (26.5 GHz)
- 3RF = 3.5mm ruggedized female (26.5 GHz)
- KM = 2.92mm male (40 GHz)
- KF = 2.92mm female (40 GHz)
- KRF = 2.92mm ruggedized female (40 GHz)
- 24M = 2.4mm male (40 GHz)
- 24F = 2.4mm female (40 GHz)
- 2RF = 2.4mm ruggedized female (40GHz)

First Connector

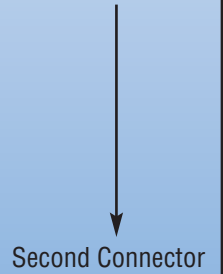

A brand new cable can have a break-in period of several hundred flexes.

# SilverLine<sup>®</sup>-VNA Flex Supreme<sup>™</sup>

Coaxial Test Cables

(50 & 67 GHz)

ISO 9001 Certified

- **Communications:**  
*Inter-satellite, point-to-point & wireless HDMI*
- **Wafer Test:**  
*Probe connections*
- **Electronic Warfare:**  
*Targeting/tracking systems*
- **Research:**  
*Component & subsystem development*

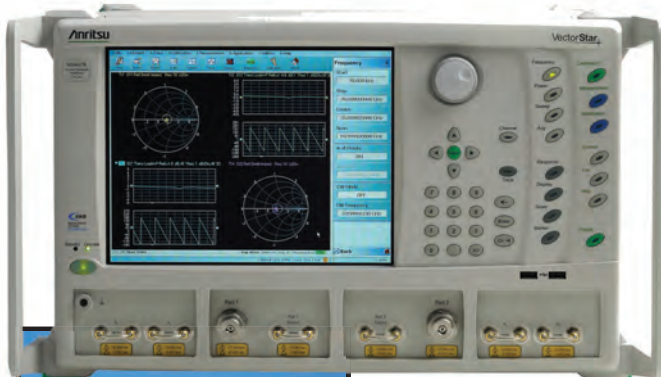

Photo courtesy Anritsu



SilverLine<sup>®</sup>-VNA Flex Supreme<sup>™</sup> 50 & 67 GHz are extremely flexible, very high frequency coax cable assemblies designed for Vector Network Analyzer use. The high flexibility is ideal for use with small or delicate circuitry. “Light” armoring helps reduce accidental damage without adding excess weight and/or inhibiting flexibility. A Nomex<sup>®</sup>, abrasion resistant outer braid improves feel and handling characteristics.

SilverLine<sup>®</sup>-VNA Flex Supreme<sup>™</sup> 50 & 67 GHz are also phase, amplitude & return loss stable over many thousands of flexes when handled in accordance with Times’ recommendations.

## Features & Benefits:

- Extremely flexible
- Long flex life
- Torque resistant outer armor
- Nomex<sup>®</sup> outer sleeve
- 2.4mm & 1.85 male and female connectors
- ROHS Compliant

# SilverLine®-VNA Flex Supreme™ (50 & 67 GHz)

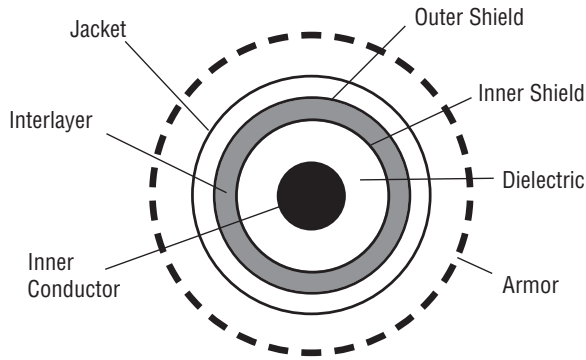

## Cable Construction:

### Inner Conductor:

Solid silver plated copper.

### Dielectric:

Micro-porous PTFE.

### Inner Shield:

Helically wound silver plated copper flat strip.

### Outer Shield:

Silver plated copper round wire braid

### Jacket: FEP

### Armor:

Stainless steel flat coil, stainless steel torque resistant wire braid, PVC jacket, Nomex® abrasion resistant sleeve.

### Connectors:

Stainless steel. Solder contact and braid. Additional crimp to armor for added torque resistance.

\*See SilverLine-VNA 26.5 & 40 GHz data sheet for test details or contact your Times representative.

## Physical & Mechanical Specifications

Dimensions	in	mm
Outside Diameter	0.308	7.8
Min bend radius (for max flex life)	1 (4)	25 (100)
Flex life (min)*	50,000	
Crush Resistance (armored)	188 lbs per linear inch	
Mating Life Cycle**	500	
Temperature Range	-67°/+194°F	-55°/+90°C

## Electrical Specifications

VSWR Max	50 Ghz	67 Ghz
	1.3:1	1.4:1
Impedance	50 Ohms	
Velocity of Propagation	78%	
Shielding Effectiveness	>100dB	
Capacitance	25.9 pf/ft (85pf/m)	
Phase Stability typical (max) *	50 Ghz	67 Ghz
	+/-3 (+/- 8)deg	+/-5 (+/-10)deg
Amplitude Stability	+/- 0.10db	+/-0.10db
Attenuation, max @ 77°F (25°C)	50 Ghz	67 Ghz
	dB/ft (m)	dB/ft (m)
	1.04 (3.42)	1.98 (6.5)
Maximum attenuation at any frequency: $(K1 \times \sqrt{f(\text{ghz})}) + (K2 \times f(\text{ghz}))$ K1 = 0.671, K2 = 0.0135		
Cable Power Handling @77°F (25°C) sea level, watts, (max)		
Frequency (Ghz)	50 Ghz	67 Ghz
	18w	14w

## Care and Handling Guidelines:

While armored, 50 & 67 GHz cables are sensitive microwave instruments. Small, flexible cables can easily be forced beyond the recommended minimum bend radius. This will likely degrade or destroy the RF performance. All flexible cables have a limited flex life. Develop procedures that limit flexing. 2.4 and 1.85mm interfaces are delicate. Keep them meticulously clean and the center contacts concentric within the outer contact. Use a microscope to examine if necessary. DO NOT mate connectors that are dirty, suspected of being damaged or outside concentric tolerances. Connectors must be aligned when mating. Misalignment could damage the interfaces and voids the warranty. Test equipment makers publish extensive use and handling procedures on their web sites that cover these and related topics.

### ALWAYS:

- Inspect interfaces before every mate. Clean if needed.
- Gently start the coupling nut and fully thread with fingers first.
- Hand tighten, but if a calibrated torque wrench is used 8 lbs max.
- Limit use to experienced technicians.
- Cap connectors and store cables separately in a protective container.
- Keep a spare pair of cables ready, just in case.

### NEVER:

- Force the cable to bend beyond the recommended minimum radius.
- Force two connectors. If any resistance is felt STOP and examine.
- Mate to another series.
- Mate connectors that are not aligned and concentric.
- Put foreign or dirty objects into the interface.

### Warranty

Product to be free from workmanship and materials defects and to meet stated data sheet performance for a period of 90 days. Excludes cable or connector interface damage from misuse, abuse, mishandling or mis-mating outside the data sheet recommendations. Warranty claims are subject to factory analysis and may include analysis charges depending on findings.

## Ordering Information

SilverLine Steel Armored, VNA  
(Nomex® cover)

Every half foot or quarter meter. 2 ft (0.75) shortest, 6 ft, (2m) longest.

SLSVXX-XXXXXX-XX.XXX

50 = 50 GHz  
67 = 67 GHz

F = Feet  
M = Meter

### Connector Codes

18M = 1.85mm male  
18F = 1.85mm female  
1RF = 1.85mm ruggedized female  
24M = 2.4mm male  
24F = 2.4mm female  
2RF = 2.4mm ruggedized female

First Connector  
↓  
Second Connector

A brand new cable can have a break-in period of several hundred flexes.

\*\*Mating life requires hand tightening and/or the strict use of a calibrated torque wrench and clean interfaces that are within the IEEE 287 precision connector standards.

# SilverLine<sup>®</sup>-VNA (110 GHz)

## Coaxial Test Cables

ISO 9001 Certified

- **Automotive:**  
*Collision avoidance radar test*
- **Communications:**  
*Point-to-point backhaul system test*
- **Wafer Test:**  
*Probe Connections*
- **Electronic Warfare:**  
*Targeting/tracking systems.  
Satellite testing*
- **Environmental:**  
*Remote atmospheric sensing*



Photo courtesy of Anritsu



Photo courtesy of Keysight



SilverLine<sup>®</sup>-VNA 110 GHz is an armored, extremely high frequency coax cable assembly designed for use where waveguide is impractical.

SilverLine<sup>®</sup>-VNA 110 GHz now offers the user working in these frequencies an alternative to the limited selection of semi-rigid solutions offered by current suppliers. Test technicians experienced in the use and handling of traditional 110 GHz products will find Times' solution to be more than competitive for RF stability and overall product life.

### Features & Benefits:

- Flexible / rebendable
- Steel armored, torque resistant
- Nomex outer sleeve
- 1.0mm male and female connectors
- ROHS Compliant

# SilverLine<sup>®</sup>-VNA (110 GHz)

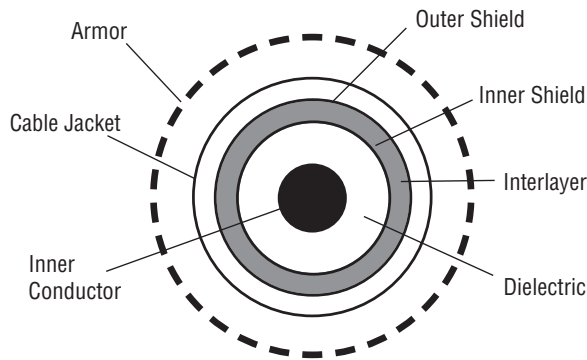

## Cable Construction

### Inner Conductor:

Solid silver plated copper.

### Dielectric:

Micro-porous PTFE

### Inner Shield:

Helically wound silver plated copper flat strip.

### Outer Shield:

Silver plated copper round wire braid.

### Jacket: FEP

### Armor:

Stainless steel flat coil, stainless steel torque resistant wire braid, PVC jacket, nomex abrasion resistant sleeve

## Care and Handling Guidelines:

While armored, 110 GHz cables are sensitive microwave instruments. Flexible cables can easily be forced beyond the recommended minimum bend radius. This will likely degrade or destroy the RF performance. All flexible cables have a limited flex life. Develop procedures that limit flexing. 1.0mm interfaces are delicate. Keep them meticulously clean and the center contacts concentric within the outer contact. Use a microscope to examine if necessary. DO NOT mate connectors that are dirty, suspected of being damaged or outside concentric tolerances. Connectors MUST be aligned when mating. Misalignment will damage the interfaces and voids the warranty. Test equipment makers publish extensive use and handling procedures on their websites that cover these and related topics.

### Always:

- Inspect interfaces before every mate. Clean if needed.
- Gently start the coupling nut and fully thread with fingers first.
- Hand tighten, but use a calibrated torque wrench to tighten. 4 lbs max.
- Limit use to experienced technicians.
- Cap connectors and store cables separately in a protective container.
- Keep a spare pair of cables ready, just in case.

### NEVER:

- Force the cable to bend beyond the recommended minimum radius.
- Force two connectors. If any resistance is felt STOP and examine.

### Warranty

Product to be free from workmanship and materials defects and to meet stated data sheet performance for a period of 90 days. Excludes cable or connector interface damage from misuse, abuse, mishandling or mis-mating outside the data sheet recommendations. Warranty claims are subject to factory analysis and may include analysis charges depending on findings.

Physical & Mechanical Specifications		
Dimensions	in	mm
Outside Diameter	0.18	4.6
Min Bend Radius (Rebendable)	0.40 (1.0)	10 (25)
Mating Life Cycle	500	
Temperature Range	-65° C - +125° C	
Electrical Specifications		
VSWR (DC-110 GHz)	1.25:1 typical 1.40: max	
Impedance	50 Ohms	
Velocity of Propagation	78%	
Shielding Effectiveness	>100 dB	
Capacitance	25.9 pf/ft (85pf/m)	
Phase Stability (over 2000 flexes <sup>1</sup> )	+/- 10°	
Time Delay	4.3ns/m	
Attenuation, max @ 77° (25° C)		
	Frequency (GHz)	dB/m
	50	10.76
	72	13.06
	84	14.19
	96	15.24
	110	16.42

Maximum attenuation at any frequency:  $(K1 \times \sqrt{f(\text{GHz})}) + (K2 \times f(\text{GHz}))$  K1=1.430, K2=0.0129

### Connectors:

Stainless steel. Solder contact and braid. Additional crimp to armor for added strength and torsion resistance.

1. Standard "tick-tock" flex test. Contact Times for test details.

## Ordering Information

### SilverLine Steel Armored VNA

(Nomex<sup>®</sup> cover)

SLSV 110-XXXXXX-CM

110 GHz

Whole centimeters  
(7 cm min, 45 cm  
max length)

### Connector Codes

10M = 1.0mm Male

10F = 1.0mm Female

First Connector  
↓  
Second Connector

A brand new cable can have a break-in period of several hundred flexes.

\*Mating life requires hand tightening and/or the strict use of a calibrated torque wrench and clean interfaces that are within the IEEE 287 precision connector standards.

# SilverLine<sup>®</sup>-TG TuffGrip<sup>®</sup>

## Coax Test Cables



ISO 9001 Certified

For Wireless System Testing:

- Cell Site Antenna & Cable Sweep Test
- Troubleshooting
- RF Maintenance
- Field RF Test



Shortened Grip

*SilverLine<sup>®</sup>-TG (TuffGrip<sup>®</sup>)* test cables are designed for sweep testing cellular infrastructure site cables and antennas. Its unique features were designed by field technicians for field technicians.

TuffGrip<sup>®</sup> employs a hefty handgrip at the system end to better withstand the rigors of field work. It meets the demands of repeated mating and unmating to cell tower cables with connectors that may have degraded from exposure.

The robust hand grip allows the user to apply as much resistance as necessary to properly torque the system cable connector, while preventing excess torque from being applied to the high performance test cable. A proper connection may now be made quickly with a single wrench.

TuffGrip<sup>®</sup> test cables are steel armored and include a steel braid overlay for excellent crush and torque resistance yet they remain very flexible. All connectors are stainless steel for thousands of mating cycles.

### Features & Benefits:

- RF stable with flexure for accurate measurements
- Rugged construction for long life in field use
- > 50,000 flex life cable for added assurance
- High frequency operation to meet future needs
- Permanently attached heavy duty protective caps
- **NEW short grip option**

*Times' SilverLine-TG<sup>®</sup> Replacement Guarantee*  
Times will repair or replace your SilverLine-TG test cable at its option if the connector attachment fails within one year of shipment. Excludes cable or connector interface damage from misuse or abuse.



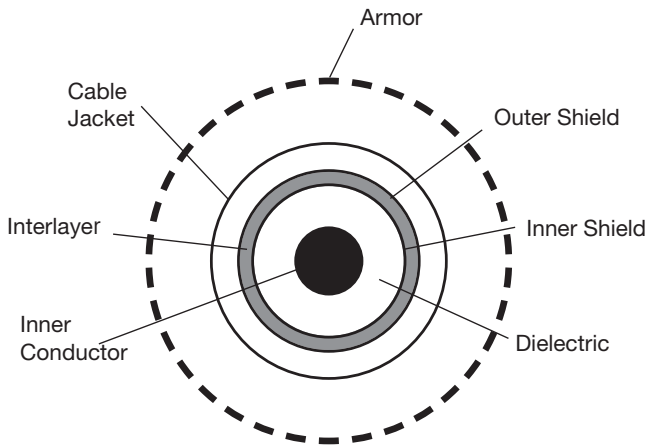

**Cable Construction**

**Inner Conductor:** Solid silver plated copper clad steel

**Dielectric:** Solid PTFE

**Shield:** Silver-plated copper flat ribbon braid  
Aluminum-Polyimide tape interlayer 36 GA silver-plated copper round braid (90%k)

**Jacket:** Clear FEP

**Armor:** Full, 100% non-interleaved spiral steel sheath overlaid with captured, opposing-force structure for anti-torque resistance. Waterproof, UV resistant, black TPR outer jacket

**Connectors**

- Passivated stainless steel finish
- Captive contact
- Precision grade connectors
- 7-16 male includes retractable coupling nut with **Times** exclusive OneTurn™ fast mating feature
- Knurl/hex Type N coupling nut

**Connector Attachment**

- System side: TuffGrip® (patented)
- Analyzer side: solder/clamp/crimp

**Ordering Information**

SLSXX-NMXXXX-XX.XXM

06 = 6 GHz

18 = 18 GHz (NFG only)

NM = Type N male

S = Short grip (N female only)

NFG = N female TuffGrip®

7FG = 7-16 female TuffGrip®

7MG = 7-16 male TuffGrip® with OneTurn™ retractable coupling nut

Meters  
01.50 = 1.5 m  
03.00 = 3.0 m  
05.00 = 5.0 m



Shortened Grip

**Mechanical Specifications**

Dimensions	in	mm
Armored O.D.	0.430	10.92
Minimum Bend Radius	2.50	63.5
Connector Retention	<290 lbs.	
Armor Crush Resistance	>1200 lbs. per linear inch	
Mating Life Cycle	>5000*	
Flex Life	>50,000**	
Temperature Range	-67° / +221°F	-55° / +105°C

**Electrical Specifications**

Impedance	50 Ohms	
Velocity of Propagation	70 %	
Shielding Effectiveness	>100 dB	
Capacitance	29.4 pf/ft = 96.4 pf/m	
Phase Stability (ten, 4" radius, 180° reverse bends)	DC to 10 GHz: +/- 1.1° 10 to 18 GHz: +/- 2.0°	

VSWR Max		6 Ghz	18 Ghz
		Type N	1.20:1
	7-16	1.25:1	

**Attenuation Max @ +77°F (+25°C)**

Frequency	GHz	dB/100 ft	dB/100 m
	1.0	12	40
	2.0	18	59
	6.0	34	112
	18.0	68	224

**Power Handling @ 77°F (25°C) (Sea Level) (Cable Only)\*\*\***

Frequency Ghz	
1	539
2	363
6	180
18	88

Specifications subject to change without notice.

\*Assumes the use of a calibrated torque wrench, proper care and cleaning of interface, and mated connector is within mil spec limits.

\*\* Minimum bend radius not to be exceeded.

\*\*\* Connector configuration may limit cable assembly maximum power handling capability.

# SilverLine<sup>®</sup>-DAS (Low PIM)

ISO 9001 Certified

## *Low PIM Test Leads for DAS Systems and Component Testing*

- *Rugged Armored Construction For:*
  - *Consistent Measurements*
  - *Long Life*
- *Superior to Un-armored Corrugated Test Leads*



SilverLine<sup>®</sup>-DAS is specifically designed for stable, low PIM performance and to withstand the flexing that occurs when testing indoor DAS systems in tight spaces. It features steel armor to resist over-bending and a highly robust strain relief. Both contribute to long product life and consistent, repeatable measurements.

SilverLine<sup>®</sup>-DAS is available with 7-16 DIN and Type N connectors. It is suitable for use with the latest generation of portable field PIM analyzers.

### **Features & Benefits**

- Won't kink like corrugated cable
- Better than -117 dbm (-160 dbc) performance\*
- Low attenuation
- RoHS compliant

\*Cable at rest or in motion  
Portable Analyzer picture courtesy of Kaelus

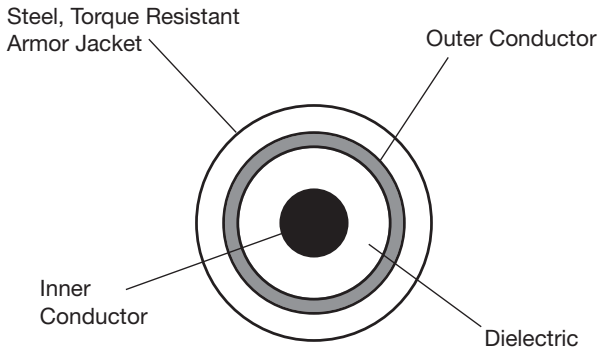

### Cable Construction

**Inner Conductor:** Solid copper clad aluminum

**Dielectric:** Low density tape wrapped PTFE or foam polyethylene

**Shield:** Helical corrugated copper

**Armor:** Full, 100% non-interleaved spiral steel sheath. Waterproof, UV and abrasion resistant, Black TPE outer jacket

**Connectors:** Low PIM, Tri-Metal plated brass

**Connector Attachment:** Fully soldered center contact and shield. Attachment includes a three layer, glue lined, heat activated sleeving with progressive flexibility

### To Achieve High Mating Life:

- Inspect and clean interfaces frequently
- Flush with alcohol or swab to remove dirt, debris, and metal particles
- Protect interface from damage
- Replace protective caps when not in use
- Install sacrificial male/female low PIM adapter Replace when needed

### Best Practices For Accurate PIM Measurements:

- Assure all interfaces are clean
- Push on and hand tighten test lead
- Tighten with a calibrated torque wrench
- DO NOT use wrenches with “teeth”
- -117 to -125 dbm variations are normal
- If spikes occur loosen and retighten one end at a time
- Blow out interfaces with dry compressed air
- Flex as little as possible. DO NOT over-bend

Mechanical Specifications		
Dimensions	in	mm
Armor	0.48	12.0
Armor Crush Resistance	>600 lbs. per linear inch	
Minimum Bend Radius	4.5	115
Length Tolerances	+/-2% of length	
Storage Temperature	-40° / +185°F	-40C / +85C
Electrical Specifications		
Passive Intermodulation (min)	-117 dbm (-160 dbc) at rest or in motion	
VSWR (ret. loss) DC -3 Ghz	1.25:1 (19 db) typ. 1.35:1 (36.54 db) max	
Impedance	50 Ohms	
Velocity of Propagation	Foam PE: 84%	PTFE tape: 76%
Shielding Effectiveness	>-100db	
Capacitance	24.2 pf/ft	79.4 pf/meter
Attenuation, max @77°F (+25°C)		
Frequency (Mhz)	dB/100 ft	(dB/100 m)
800	5.3	(17.4)
900	5.6	(18.5)
1800	8.2	(26.9)
1900	8.5	(27.7)
2100	8.9	(29.2)
3000	10.9	(35.6)
Power Handling @77°F (+25°C) (Watts, average) (Sea Level) (Cable Only)		
Mhz	Watts (average)	
800	420	
900	400	
1800	270	
1900	260	
2100	250	
3000	210	

\*Specifications subject to change without notice.

### Ordering Information

For the most accurate measurement results limit length to 2.75 meters.

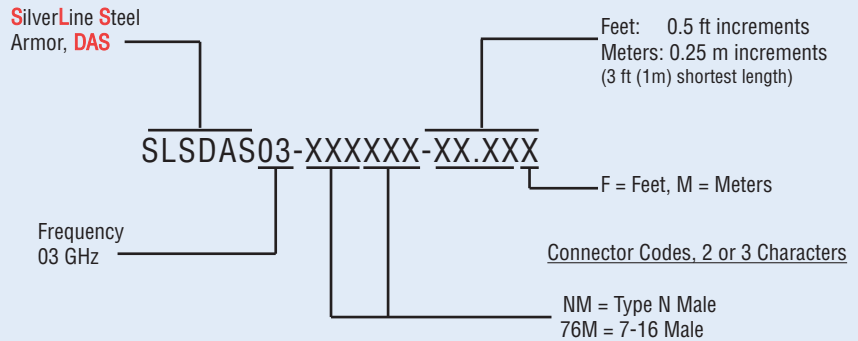

# SilverLine<sup>®</sup>-LP (Low-PIM)

ISO 9001 Certified

## Coax Test Cables for Passive Intermodulation Testing

- Cellular Site Certification
- Troubleshooting
- Performance Analysis
- Antenna or Radio Equipment Production Test
- *Elliptical Body Improves Grip Force*
- *Now 20% Lighter Weight*
- *Improved Strain Relief*



SilverLine<sup>®</sup>-LP is the first test cable specifically designed for field and production PIM Testing. Unlike standard corrugated test leads that experience rapid failures due to kinking and connector/cable interface breakage, SilverLine<sup>®</sup>-LP is steel armored. It has a large back shell and strain relief to protect the cable to connector interface against almost all possibilities for damage. This robust design improves product life and reduces the occurrence of faulty test results.

SilverLine<sup>®</sup>-LP is ideal for use with Portable PIM analyzers in field test applications. It is also ideal for use with bench top PIM Analyzers in a lab or factory production environment. In the field this reliable, high quality test cable cuts costs by eliminating the need to rebuild or re-terminate a test lead on site or worse, cancel a test entirely. In the factory it saves labor by providing more accurate and consistent results over a far longer product life. This reduces product rejects caused by faulty test leads.

In the uncertain world of PIM, SilverLine<sup>®</sup>-LP is an excellent value, reducing reoccurring costs.

### Features and Benefits:

- Much easier to handle than raw corrugated cable
- Better than -117dbm (-160dbc) Performance
- Includes a set of low PIM adapters
- Low attenuation
- Rugged, durable, steel armored design
- Water resistant
- RoHS compliant

Times **Silverline<sup>®</sup>** Product Guarantee  
SilverLine<sup>®</sup>-LP is warranted for one year against defects in workmanship and materials. Excludes damage from over-bending, interface wear, contamination from dirt or other foreign materials, misuse, abuse or unauthorized disassembly.

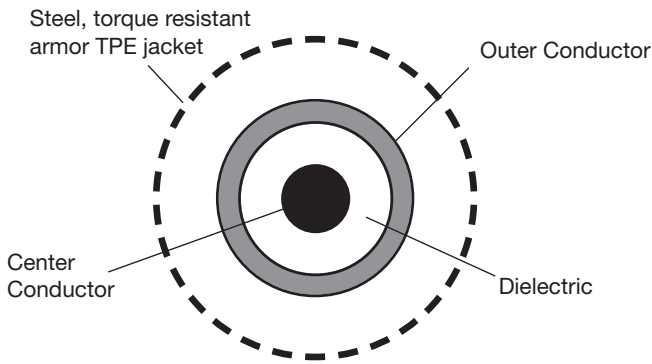

**Cable Construction**

**Inner Conductor:** Solid copper clad aluminum

**Dielectric:** Low density tape wrapped PTFE or foam polyethylene

**Shield:** Helical corrugated copper

**Armor:** Full, 100% interlocked spiral steel sheath overlaid with steel, anti-torque braid. Waterproof, UV & abrasion resistant, Black TPE outer jacket

**Connectors:**

- Body: Tri-Metal plated brass
- Back Shell: Aluminum
- New Dynaflex® molded strain relief
- Water resistant

**Connector Attachment:** Soldered center contact & shield. Attachment includes a ribbed, wedge clamp-to-armor for the strongest, most robust retention system in the industry.

**\*Achieving a high mating life cycle:**

- Inspect and clean interfaces frequently
- Flush with alcohol or swab to remove dirt, debris, and metal particles
- Protect interface from damage
- Replace protective caps when not in use
- Install sacrificial male/female low PIM adapter Replace when needed

Physical & Mechanical Specifications		
Dimensions	in	mm
Armor	0.59	14.99
Weight: lbs/ft (kg/m)	Cable & Armor Combined: 0.258 (0.383)	
Armor Crush Resistance	>1200 lbs per linear inch	
Bend Radius (min)	7.5"	190.5mm
Mating Life Cycle	1000*	
Storage Temperature	-40°/+185°F	-40°/+85°C
Electrical Specifications		
PIM	-117 dbm (-160 dbc) min. at rest**	
VSWR (ret. loss) DC - 3 GHz	1.25:1 (19db) typ. 1.35:1 (16.54db) max	
Impedance	50 Ohms	
Velocity of Propagation	Foam PE: 84%	PTFE tape: 76%
Shielding Effectiveness	> -100db	
Attenuation Max	@ 77°F (+25°C)	
	MHz	db/100 ft db/100m
	800	3.6 11.8
	900	3.9 13.0
	1800	5.6 18.7
	1900	5.8 19.0
	2100	6.2 20.1
	3000	7.5 24.7
Power handling @77°F (+25°C)(Watts, Avg.)(Sea Level)(Cable Only)		
	MHz	Watts (average)
	800	946
	900	729
	1800	460
	1900	445
	2100	430
	3000	340

Specifications subject to change without notice.

**\*\*Best Practices for accurate PIM measurements:**

- Assure all interfaces are clean
- Push on and hand tighten test lead
- Tighten with a calibrated torque wrench
- DO NOT use wrenches with “teeth”
- -117 to -125 dbm variations are normal
- If spikes occur loosen and retighten one end at a time
- Blow out interfaces with dry compressed air
- Flex as little as possible. DO NOT over-bend

# PIM Performance and Return Loss vs. Frequency

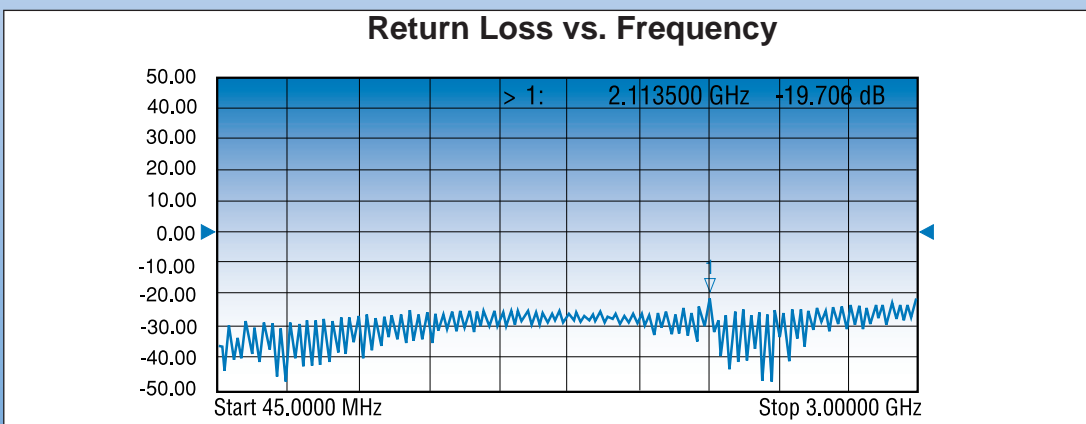
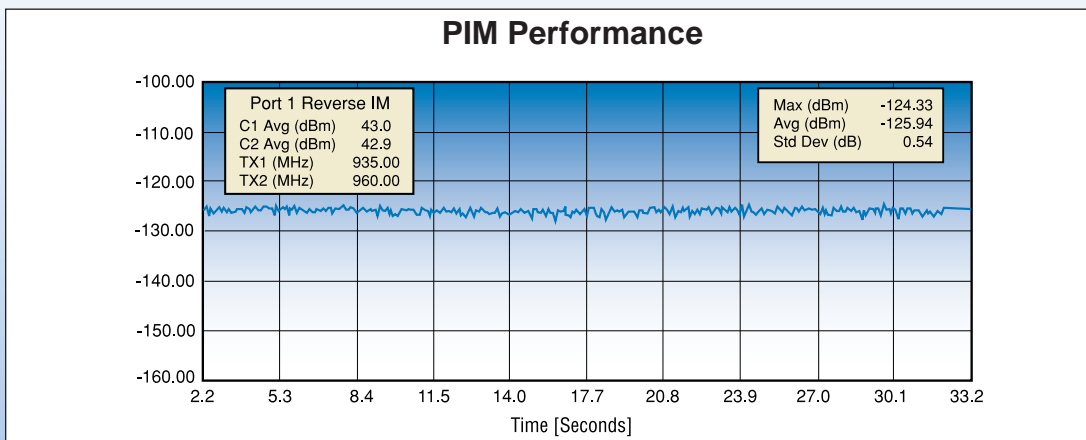

## Ordering Information

SilverLine, Steel Armor, Low PIM

SLSLP03-76M76M-XX.XXMK

3 GHz

K = Includes set of three low PIM adapters.  
Omit for cable assembly only

Low PIM adapter kit PN: 660-0007EA

Every 0.25 meter length from 1.5 meters  
Example: -02.75M = 2.75m

Kit contents:



Female bullet, M-F r/a and M-F connector saver



Heavy duty nylon case with sturdy velcro closure, individual compartments, belt clip and metal lanyard

## Low PIM Accessories

### Pulsed Power Portable PIM Load (pn 67033)



Frequency:	690MHz - 2800MHz
<b>Size: in (mm)</b>	<b>6.4L x 1.6w (163 x 40)</b>
<b>Approx Weight:</b>	<b>1.1 lbs. (0.5kg)</b>
Impedance:	50 Ohms
Return Loss:	16 db min
Intermodulation:	-160 dbc (2 x 43 dbm carriers)
Power Handling:	10 watts average
Coupling Torque:	21 ft-lbs (29 N*m) min 36 ft-lbs (49 N*m) max
Operating Temp:	14-130°F (-10-55°C)
Connector Type:	7-16 male, 7-16 female

### Portable PIM Load (pn 67019)

Frequency:	690MHz - 2800MHz
<b>Size: in (mm)</b>	<b>10.4L x 3w (263 x 76)</b>
<b>Approx Weight:</b>	<b>3.4 lbs. (1.54kg)</b>
Impedance:	50 Ohms
Return Loss:	16 db min
Intermodulation:	-165 dbc (2 x 43 dbm carriers)
Power Handling:	40 watts average
Coupling Torque:	21 ft-lbs (29 N*m) min 36 ft-lbs (49 N*m) max
Operating Temp:	32-95°F (0-32°C)
Connector Type:	7-16 male, 7-16 female



### SilverLine-LPA (Low PIM Adapters)

3191-331 = 7-16 female bullet	3191-397 = Type N female/Type N female
3191-332 = 7-16 male/female right angle	3191-411 = 4.1/9.5 female/Type N female
3191-376 = 7-16 male bullet	3191-412 = 4.1/9.5 female/Type N male
3191-377 = 7-16 male/female	3191-413 = 4.1/9.5 male/Type N female
3191-378 = 7-16 male/Type N male	3191-414 = 4.1/9.5 male/Type N male
3191-379 = 7-16 male/Type N female	3191-415 = 4.3/10 female/7-16 female
3191-380 = 7-16 female/Type N female	3191-416 = 4.3/10 male/7-16 female
3191-381 = 7-16 female/Type N male	3191-417 = 4.3/10 female/Type N male
3191-382 = 7-16 male/female 45°	3191-418 = 4.3/10 male/Type N male
3191-387 = 7-16 female/female 45°	3191-419 = 4.1/9.5 female/7-16 male
3191-394 = 4.1/9.5 male/7-16 female	3191-420 = 4.1/9.5 male/7-16 male
3191-395 = 4.1/9.5 female/7-16 female	3191-421 = 4.3/10 female/7-16 male
3191-396 = Type N male/Type N male	3191-422 = 4.3/10 male/Type N female

For complete information see the SilverLine® LPA data sheet

# SilverLine<sup>®</sup>-LPA

*DIN, Mini-DIN & Type N for PIM Sensitive Systems*

## Low PIM Adapters

*ISO 9001 Certified*

- *Cellular or Wireless*
- *Tower or in-building*
- *Production or laboratory*



SilverLine<sup>®</sup>-LPA low PIM adapters exhibit exceptional PIM performance in any cellular or wireless frequency range.

Times uses only the most robust designs for long product life regardless of the environment. All product is 100% tested and individually packaged prior to shipping.

**Two 45° Configurations!**





Mechanical Specifications	
Body and Coupling Nut	Tri-metal plated brass
Center Contact	Gold or Silver Plated
Mating Life	500 min*
Temperature Range	-40° C to +85° C
Electrical Specifications	
Frequency, Max	All straight configurations 45° or right angle 6 Ghz 3Ghz
Impedance	50 Ohms
VSWR, Max	All straight configurations 45° or right angle 1.1:1 (3 Ghz) 1.2:1 (6 Ghz) 1.25:1
PIM* (IM3)	-125 dBm +/- 3 dBm (2 x 43 dBm carriers)

\* Interfaces must be clean and proper torque forces applied

## Ordering Information

### Individual Adapters:

3191-331 = 7-16 female bullet  
 3191-332 = 7-16 male/female right angle  
 3191-376 = 7-16 male bullet  
 3191-377 = 7-16 male/female  
 3191-378 = 7-16 male/Type N male  
 3191-379 = 7-16 male/Type N female  
 3191-380 = 7-16 female/Type N female  
 3191-381 = 7-16 female/Type N male  
 3191-382 = 7-16 male/female 45°  
 3191-387 = 7-16 female/female 45°  
 3191-394 = 4.1/9.5 male/7-16 female  
 3191-395 = 4.1/9.5 female/7-16 female  
 3191-396 = Type N male/Type N male  
 3191-397 = Type N female/Type N female

### Kit Designator

A  
B  
C  
D  
E  
F  
G  
H  
I  
J  
K  
L  
M  
N

3191-411 = 4.1/9.5 female/Type N female  
 3191-412 = 4.1/9.5 female/Type N male  
 3191-413 = 4.1/9.5 male/Type N female  
 3191-414 = 4.1/9.5 male/Type N male  
 3191-415 = 4.3/10 female/7-16 female  
 3191-416 = 4.3/10 male/7-16 female  
 3191-417 = 4.3/10 female/Type N male  
 3191-418 = 4.3/10 male/Type N male  
 3191-419 = 4.1/9.5 female/7-16 male  
 3191-420 = 4.1/9.5 male/7-16 male  
 3191-421 = 4.3/10 female/7-16 male  
 3191-422 = 4.3/10 male/Type N female

### Kit Designator

O  
P  
Q  
R  
S  
T  
U  
V  
W  
X  
Y  
Z

**Standard** (small) SilverLine Adapter Kits: (Hard case with foam insert containing seven adapters)

660-0234: Contains one each A, D, E, F, G, H and I

660-0235: Contains one each A, D, G, H, I, K and L

660-0236: Contains one each A, C, M, T, W, Y and Z

*Specifications subject to change without notice*

**Custom** (Large) SilverLine Adapter Kits: (Hard case with foam. 10 pieces min, 20 max (max of four 45's or r/a's combined)

SLK-XXXXX . . . (Insert designator from above in alphabetical order (20 max) . Duplicate designators acceptable)

# Times Flex Life Testing Method

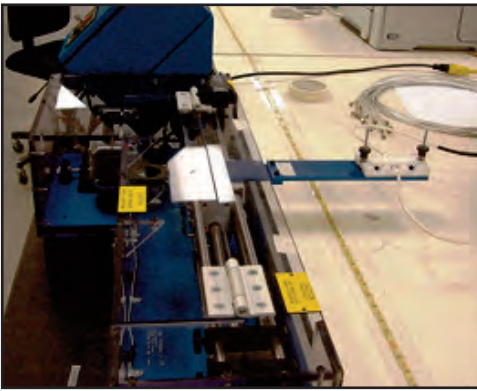

Flex Tester: Requires a 4ft cable

## Flex Test Description:

The VNA is calibrated for the max frequency of the cable. A cable is attached to both ports and the test equipment set to both display and record S11 and S22 VSWR, attenuation and phase. Unlike the 360 degree wrap test this allows real time observation and recording of performance. This test puts 4 bends in the cable at all times. Two are standard bends near the connectors and two are rolling bends at two locations along the cable. This is considered a very severe flex test.

The flex tester speed can be varied but is typically set at 20 “round trip” cycles per minute. A computer queries the VNA for data every 60 seconds. The resulting randomness means data is taken when the cable is in different physical configurations.

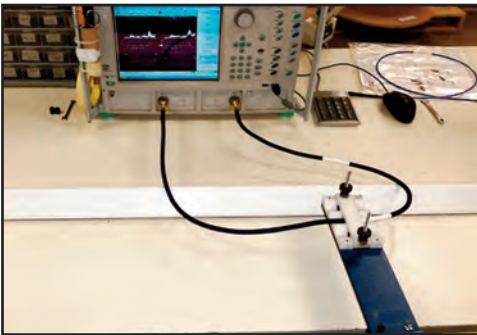

Cable is flexed +/- 10” from centerline

The VNA is run constantly for 2-3 days without recalibration. Any drift from the VNA due to time and/or changes in facility temperature are therefore included in the results, making the data worst case over the life of the test. The data is graphed and 8-hour increment markers are added to indicate how the cable's performance would change during any 8 hour production shift.

Below is a sample of what flex stability test data looks like when taken using the above method. Note the break in period on approximately the first 100 flexes. Flex test data for the actual product being considered may be available upon request. Contact your local Times representative.

## S21 - Loss Stability

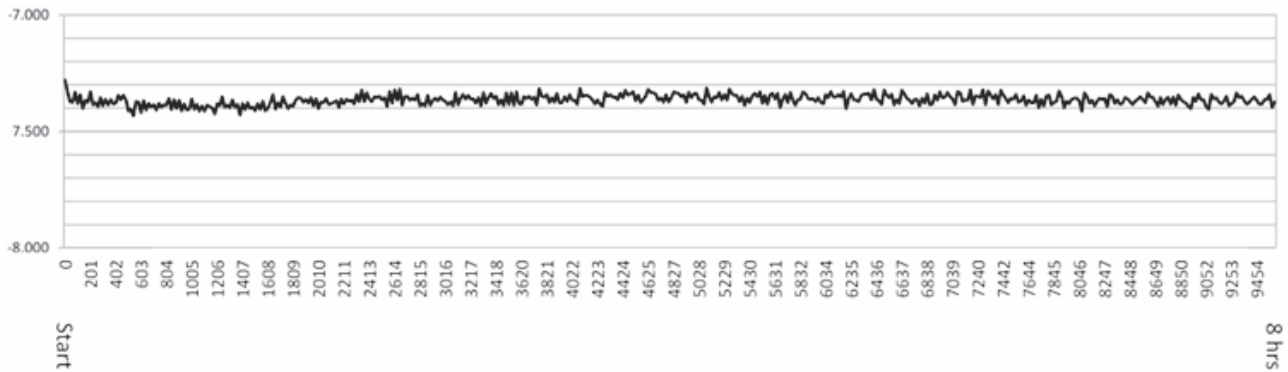

Data for times 67 HGz Flex Supreme

## S21 - Phase Stability

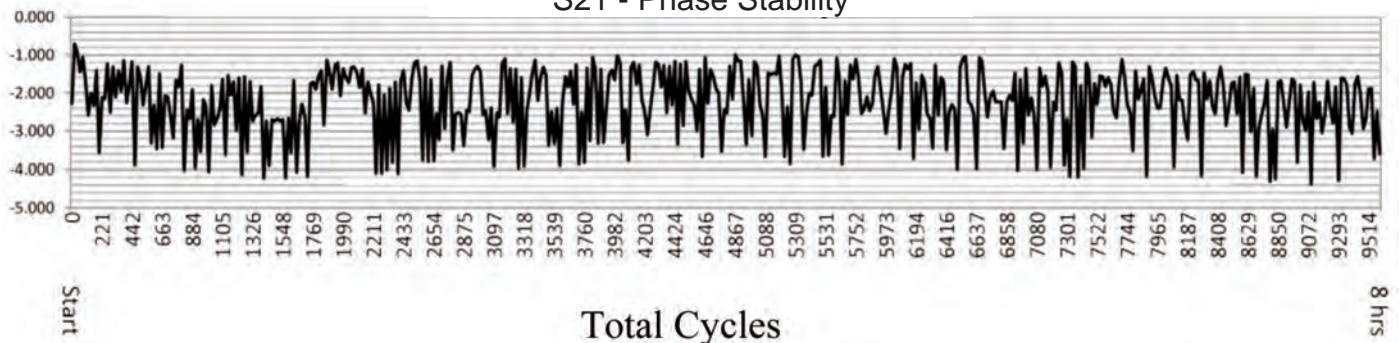

## Total Cycles

World Headquarters: 358 Hall Avenue, Wallingford, CT 06492 Tel: 203-949-8400, 1-800-867-2629 Fax: 203-949-8423

International Sales: +1 (800) 867-2629 • +1 (203) 949-8503 China Sales: TMC Building 4, No. 318 Yuanshan Road, Xinzhuang Industrial Park, Shanghai, China 201108

Tel: 86-21-5176-1209 Fax: 86-21-64424098

www.timesmicrowave.com

SL-B 12/16