

RIGHT ANGLE PLUG CRIMP TYPE

R125.154.900

CABLE .141

Series : SMA

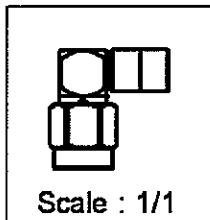
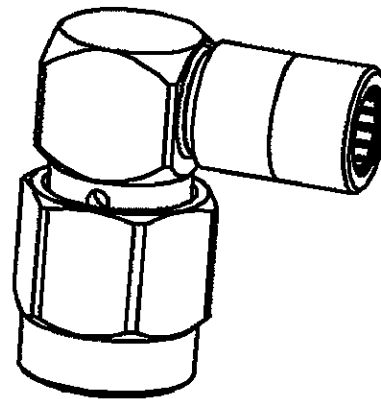
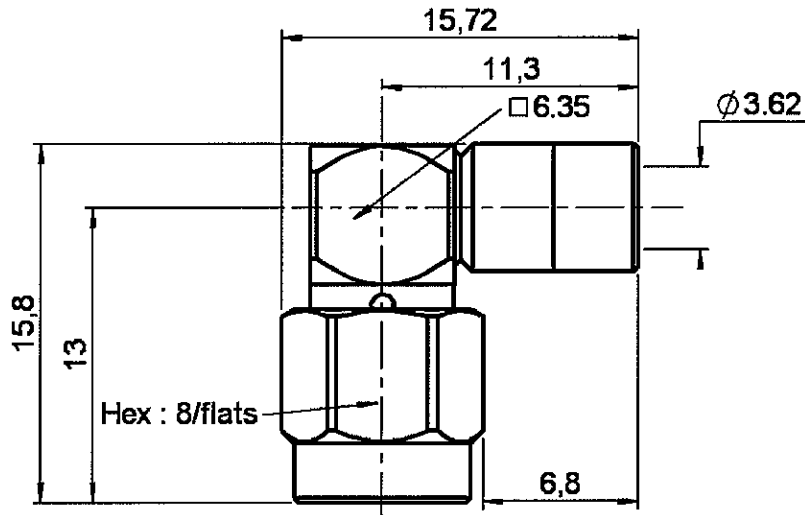

All dimensions are in mm.

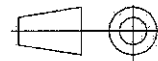

COMPONENTS	MATERIALS	PLATINGS (µm)
BODY	STAINLESS STEEL	GOLD 0.5 OVER NICKEL 2
CENTER CONTACT	BRASS	GOLD 1.3 OVER NICKEL 2
OUTER CONTACT	-	-
INSULATOR	PTFE	-
GASKET	SILICONE RUBBER	-
OTHERS PARTS	STAINLESS STEEL	GOLD 0.5 OVER NICKEL 2
-	-	-
-	-	-

Issue : 0528 C

In the effort to improve our products, we reserve the right to make changes judged to be necessary.



RIGHT ANGLE PLUG CRIMP TYPE

R125.154.900

CABLE .141

Series : SMA

PACKAGING

Standard	Unit	Other
100	'W' option	Contact us

SPECIFICATION

CABLE ASSEMBLY

ELECTRICAL CHARACTERISTICS

Impedance		50 Ω
Frequency		0-18 GHz
VSWR	1.10 +	0.010 x F(GHz) Maxi
Insertion loss		0.05 √F(GHz) dB Maxi
RF leakage	- (60 - F(GHz)) dB mini
Voltage rating		500 Veff Maxi
Dielectric withstanding voltage		1000 Veff mini
Insulation resistance		5000 MΩ mini

Stripping	a	b	c	d	e	f
mm	2.16	0.00	0.00	0.00	0.00	0.00

Assembly instruction :

Recommended cable(s)
RG 402
KS 2

Cable retention

- pull off **270** N mini
- torque **NA** N.cm

MECHANICAL CHARACTERISTICS

Center contact retention		
Axial force – Mating end		27 N mini
Axial force – Opposite end		27 N mini
Torque		2.8 N.cm mini

Recommended torque		
Mating		100 N.cm
Panel nut		NA N.cm
Clamp nut		NA N.cm
A/F clamp nut		0.000 mm

Mating life		500 Cycles mini
Weight		5.000 g

TOOLING

Part Number	Description	Hexagon
.	.	.
R282.286.000	CRIMPING TOOL	-
R282.704.000	POSITIONER	-
R282.711.000	GUIDE	
R282.066.000	POINTER GAUGE	
R282.053.000	STRIPPING TOOL	

OTHERS CHARACTERISTICS

ENVIRONMENTAL

Operating temperature		-65/+105 °C
Hermetic seal		NA Atm.cm3/s
Panel leakage		NA

Issue : 0528 C

In the effort to improve our products, we reserve the right to make changes judged to be necessary.



RIGHT ANGLE PLUG CRIMP TYPE

R125.154.900

CABLE .141

Series : SMA

COMPONENTS

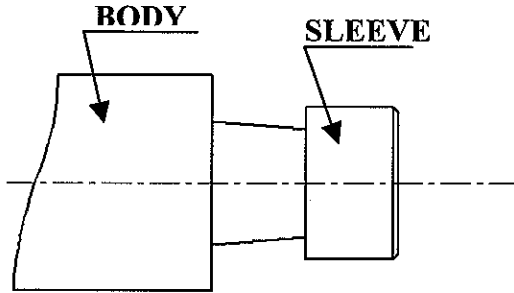

STIPPING DIMENSIONS

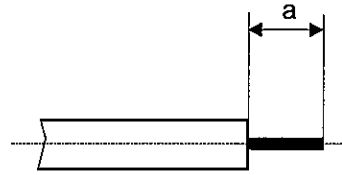

1

- Strip the cable with the cable stripping tool
- Trim the cable inner conductor with the trimmer.
- Clean the cable



3

- Insert the connector and the cable on the crimping tool with guide and positioner.
- A pneumatic crimping tool exist too that can be used

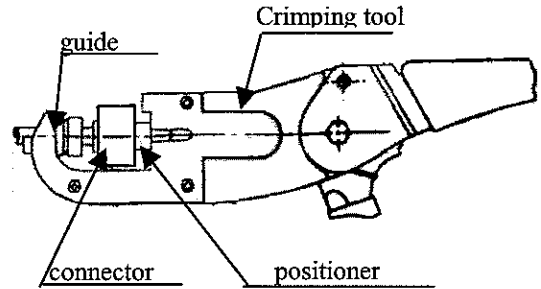

2

- Slide connector onto the cable

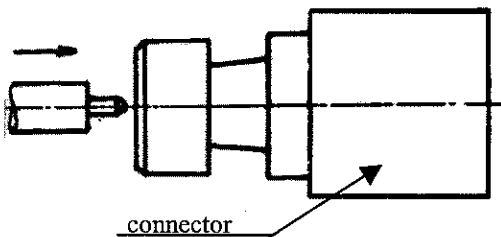

4

- Press the connector on the cable.

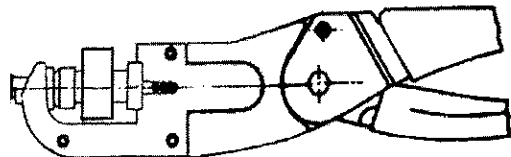

Issue : 0528 C

In the effort to improve our products, we reserve the right to make changes judged to be necessary.

