

Coaxial Cable Connector 16_SMA-50-3-3/111_N

Description

Right angle cable plug

Interface standards

IEC 60169-15_MIL-STD-348A/310_CECC 22110



Technical Data

Electrical Data

Impedance	50 Ω		
Interface frequency max.	18 GHz		
Frequency range	DC to 2 GHz	2 to 12 GHz	12 to 18 GHz
Return loss	32 dB	23 dB	10 dB

Mechanical Data

Centre contact	soldered
Outer contact	soldered
Weight	0.0045 kg

Environmental Data

Operating temperature 2011/65/EU, RoHS	-65 °C to 165 °C compliant
---	-------------------------------

Material Data

Piece Parts	Material	Surface Plating
Centre contact	Copper Beryllium Alloy	Gold Plating (Nickel underplated)
Outer contact	Copper Beryllium Alloy	Gold Plating (Nickel underplated)
Body	Brass	Gold Plating (Nickel underplated)
Insulator	PFA / PTFE	
Coupling nut	Bronze	Gold Plating (Nickel underplated)
Gasket	VMQ (Silicone rubber)	

Related Documents

Outline drawing	DOU-00005965
Catalogue drawing	DCA-00005967
Assembly instruction	DOC-0000179177

Ordering Information

Bulk 100 pcs package	16_SMA-50-3-3/111_NH
Single package	16_SMA-50-3-3/111_NE

Additional Information

Suitable cables	EZ_141_TP_M17, SUCOFORM_141, MULTIFLEX_141
-----------------	--

This drawing is copyright. Information contained thereon is supplied in confidence and must not be used for any other purpose than which it was supplied, or be reproduced without written permission of the owners.

Diese Zeichnung ist unser geistiges Eigentum und darf ohne unsere ausdrückliche Einwilligung weder kopiert, vervielfältigt, noch Dritten oder Konkurrenzfirmen zugänglich gemacht werden.

type: **16 SMA-50-3-3**

	date	sign
drawn	3/14/00	JTH
checked	3/14/00	DDE
approved	3/14/00	MAP

Cable shortening dimension

Scale 3 : 1

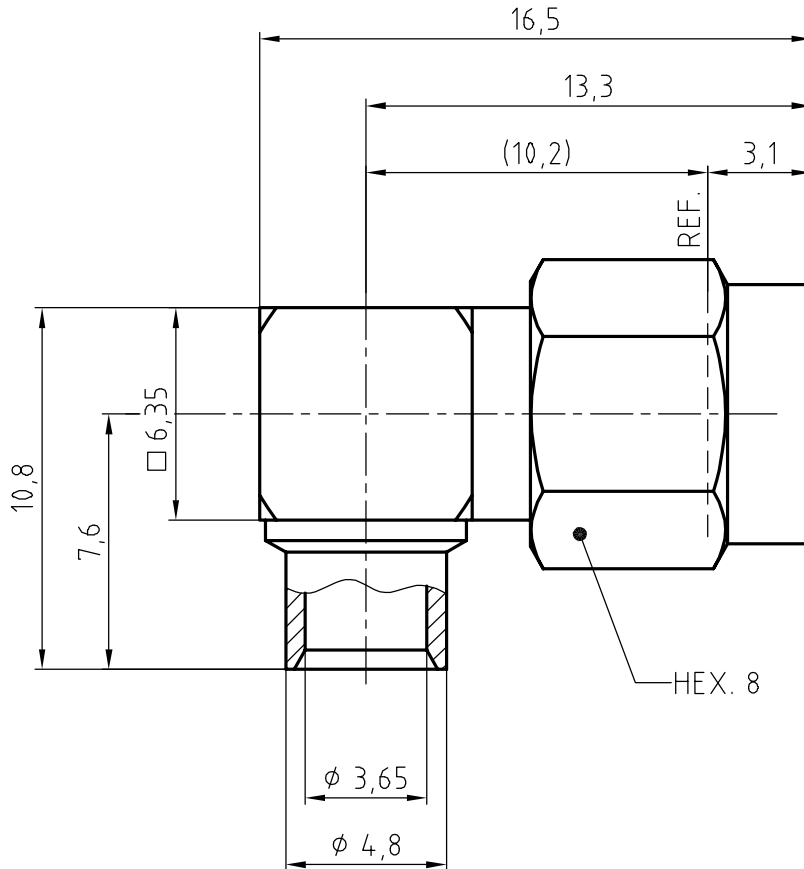
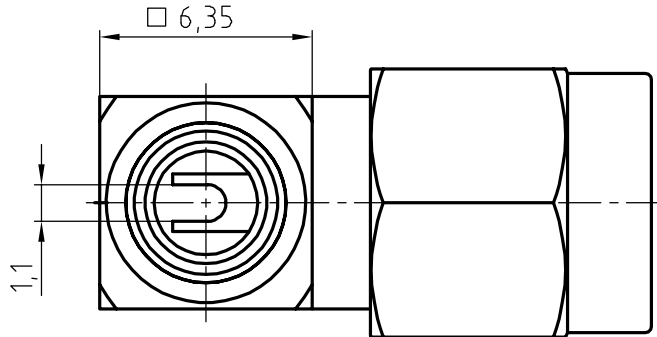
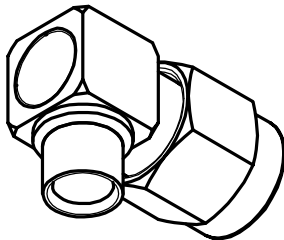
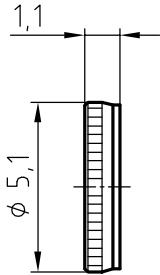
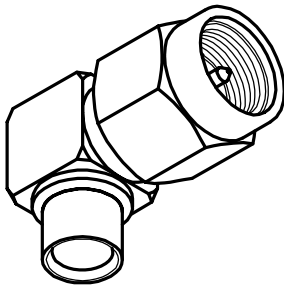
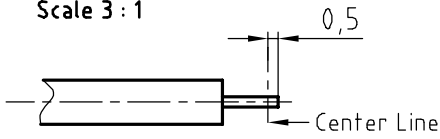

UNCONTROLLED COPY WHEN PRINTED

scale

5 : 1

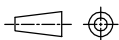

HUBER + SUHNER US-ES

dimensions in mm

drawing number

4.13.155062

QD drawing:

Index

a