

## Straight Plug

Crimp type for flexible cable:  
7202-1572-0XX

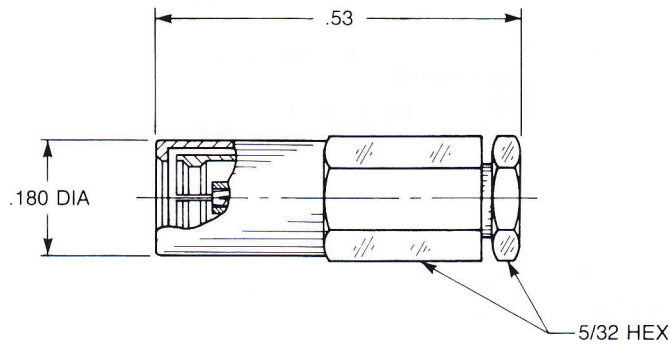

## Straight Plug

Solder type for semi-rigid:  
7202-1542-0XX

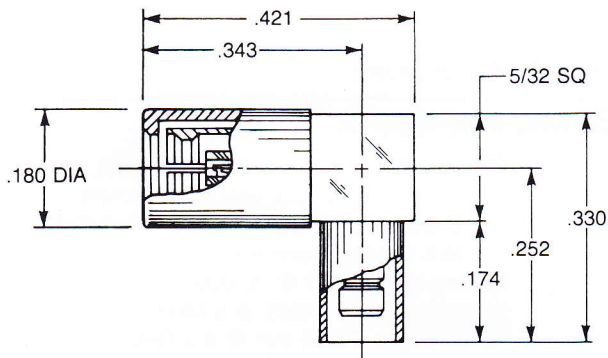

## Right Angle Plug

Crimp type for flexible cable:  
7405-1521-0XX

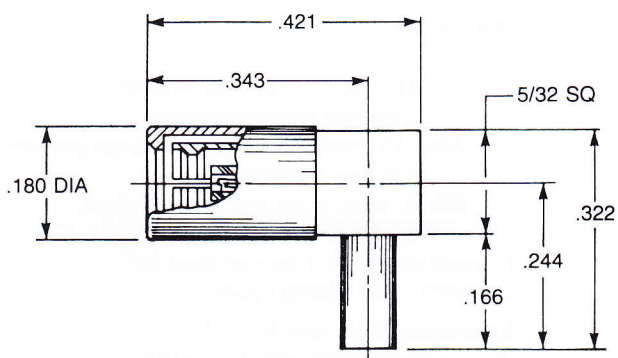

## Right Angle Plug

Solder type for semi-rigid:  
7405-1561-0XX

Substitute the appropriate cable group for 'XX':

02	RG178, RG196, M17/93, M17/169	10	.085" semi-rigid, RG405, M17/133
03	RG174, RG179, RG316, M17/113, M17/119, M17/172, M17/173	11	.047" semi-rigid, M17/151
05	RG178DS, RG196DS	19	RG174DS, RG316DS, M17/152, Times RD316
		21	.056" semi-rigid