

**SPECIFICATIONS**

**ELECTRICAL**

FREQUENCY RANGE \_\_\_\_\_ DC - 65 GHz

STANDARD dB VALUES \_\_\_\_\_ SEE CHART A

ATTENUATION ACCURACY _____	DC - 26.5 GHz	26.5 - 40 GHz	40 - 60 GHz	60 - 65 GHz
3, 6 dB _____	±0.75 dB	±1.0 dB	±1.5 dB	±1.5 dB
10 dB _____	±0.75 dB	±1.25 dB	±1.5 dB	±1.75 dB
15 & 20 dB _____	±1.0 dB	±1.25 dB	±2.0 dB	±2.5 dB
30 dB _____	±1.25 dB	±1.5 dB	±2.0 dB	±5.0 dB

VSWR (MAX) _____	DC-26.5 GHz	26.5 - 40 GHz	40 - 65 GHz
	<1.35	<1.55	<1.65

INPUT POWER (AVG. MAX.) \_\_\_\_\_ 1 WATT @25°C SEE TABLE  
DERATES LINEARLY TO 10% AT +100°C from + 25°

IMPEDANCE \_\_\_\_\_ 50 OHMS

OPERATING/STORAGE TEMP. RANGE \_\_\_ -55 TO +100°C

**MATERIAL**

HOUSING: STAINLESS STEEL IAW ASTM-A484 & ASTM-A582, ALLOY 303, COND A

CONTACT: BERYLLIUM COPPER

DIELECTRIC - TEFLON

**FINISH**

HOUSING - PASSIVATED STAINLESS STEEL

CONDUCTOR - GOLD PLATED IAW MIL-PRF-39012

**MARKING**

PART LOOKS LIKE PRODUCT IMAGE ABOVE.

PART MARKING ORIENTATION AND FORMAT AS SHOWN (CURVED SURFACE).

dB = SEE WORK ORDER FOR TWO DIGIT dB VALUE.

MARKING TO BE AS LARGE AS POSSIBLE. .020" SHOWN.

TEXT HEIGHT IS SUGGESTED ONLY, FIT AS DICTED.

YYWW EQUALS DATE CODE.

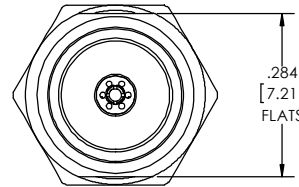
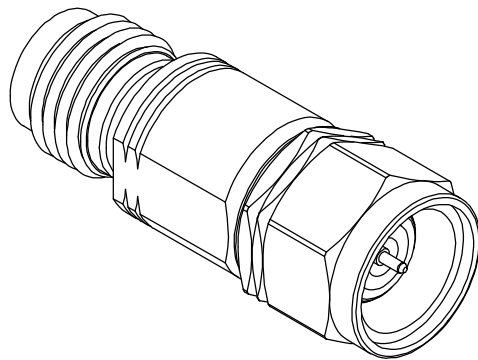

-dB	dB VALUE
03	3
06	6
10	10
20	20
30	30

REVISIONS				
REV	DESCRIPTION	ECO #	DATE	APPROVED
X2	REDRAWN IN SOLIDWORKS	14-ER016	7/18/14	T.KUHN
X3	ADDED DATE CODE	14-ER016	9/23/15	T.KUHN

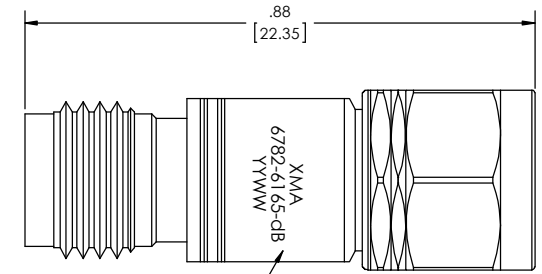
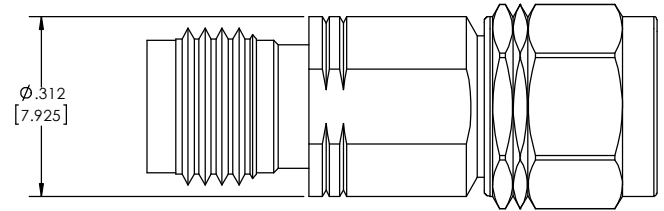

MARKING AREA  
SEE NOTE

QTY.	PART NUMBER	DESCRIPTION	ITEM NO.
X	6782-6165-dB	ATTENUATOR, 1.85mm, MALE TO FEMALE, DC-65 GHz, 1 WATT	
1	TA-6782-6165-dBU	ASSEMBLY, ATTENUATOR, 1.85mm, MALE TO FEMALE, DC-65 GHz, 1 WATT, UNMARKED	1

<small>DRAWING PRACTICES PER ANSI Y-14.5 DIMENSIONS ARE IN INCHES AND APPLY BEFORE/AFTER PROCESSING</small> SURFACE FINISH: 63 FINISH:	<small>UNLESS OTHERWISE SPECIFIED TOLERANCES IN:</small> DECIMALS INCH (MM) .X" .05" [1.27] .XX" .03" [.76] .XXX" .010" [.25]	DRAWN: MCCORMICK07/16/14 DATE: 07/16/14 CHECKED: MCCORMICK07/16/14 DATE: 07/16/14 ENG APPR: T.KUHN DATE: 07/16/14
<small>MATERIAL:</small> NOTE: THIS DRAWING INCORPORATES THIRD ANGLE PROJECTION. 	<small>ANGLES ±0°30'</small> REMOVE ALL BURRS/SHARP W/ BREAK / R OF .003" TO .0005" UNLESS OTHERWISE NOTED DIAS CONCENTRIC <.003 T.I.R. DO NOT SCALE PRINT	<small>THESE DRAWINGS AND SPECIFICATIONS ARE THE PROPERTY OF XMA CORP. OR OMNI SPECTRA AND SHALL NOT BE REPRODUCED, COPIED NOR USED IN WHOLE OR IN PART AS A BASIS FOR THE MANUFACTURE OR SALE OF OTHER ITEMS WITHOUT THE EXPRESS WRITTEN PERMISSION OF XMA CORP.</small>

Phone: 603-222-2256 Fax: 603-222-2259  
150 Dow Street, Manchester, NH 03103

ATTENUATOR, 1.85mm, MALE TO FEMALE, DC-65 GHz, 1 WATT			
SIZE: C	CAGE CODE: 3HT76	DRAWING NUMBER: 6782-6165-dB	REV: X3
SCALE:	PLATED AREA SQ. IN:	SHEET 1 OF 1	